

New Cayenne SPECIFICATION

(Cayenne 2009~)

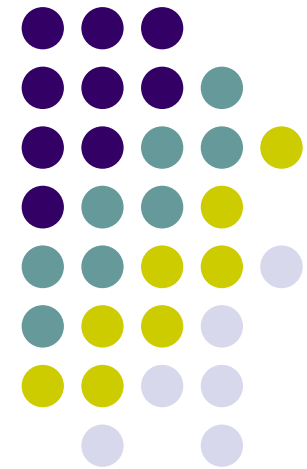

- . MODEL: LVTX-STD-V1.0
- . P/N : LVSTD-0901-000



INDEX



- New Cayenne Feature.....	3
- Precaution.....	4
- Main Spec.....	5
- System Composition.....	6
- Outline Dimension.....	7
- External Appearance	8
- Connector Pin Assignment	10
- DIP Switch Setting	12
- How to use OSD Keypad	13
- OSD(On Screen Display)	14
- FMTX Frequency Setting	19
- How to use parking guide line	20
- Product Composition	22
- Installation Structure	23
- FAQ.....	24

-New Cayenne Feature



- Improved quality**
- Auto detection for NTSC, PAL signals**
- AV source switching by original button**
- FMTX Module Built in.**
- Possible to control displayed external NAVI, AV image**

-Precaution



- You must keep the car key taken off from the car while you work this and finally, connect power of the interface.
- When to connect the interface cable, you must keep the power cable taken off.
- You must work this at the environment without any static electricity or damages.
- All of process on this installation should be done by professionals.
- You must not break the labels attached on the board, if it's broken, no warranty.
- When you receive this package you have to check whether there's any parts not included and you have to contact us right away.
- Our repair service do not accept any problems caused by user's any fault or carelessness.

-Main Spec.



1. Input Spec. (MULTI VIDEO INTERFACE)

- 3 x A/V Input (External video source).
- 1 x CVBS(REAR CAMERA) Input. (Rear camera source)
- 1 x Analog RGB Input (Navigation System output)
- 1 x LCD Input (Car system Input)
- 1 x Cayenne Input

2. Output Spec.

- 1 x Cayenne Output
- 4 x Audio Select (12V power comes out from 4wires of cable by video, Navi mode)

3. Power Spec.

- Input Power : 8VDC ~ 24VDC
- Consumption Power : 12WATT, Max

4. Switch Input mode

- Input Video MUTE Function : Possible to make each input mute by operating Dip S/W.
- Possible to switch Input mode with Keypad(or Remote control)
- Possible to switch Input mode with switch for source toggle

-System Composition

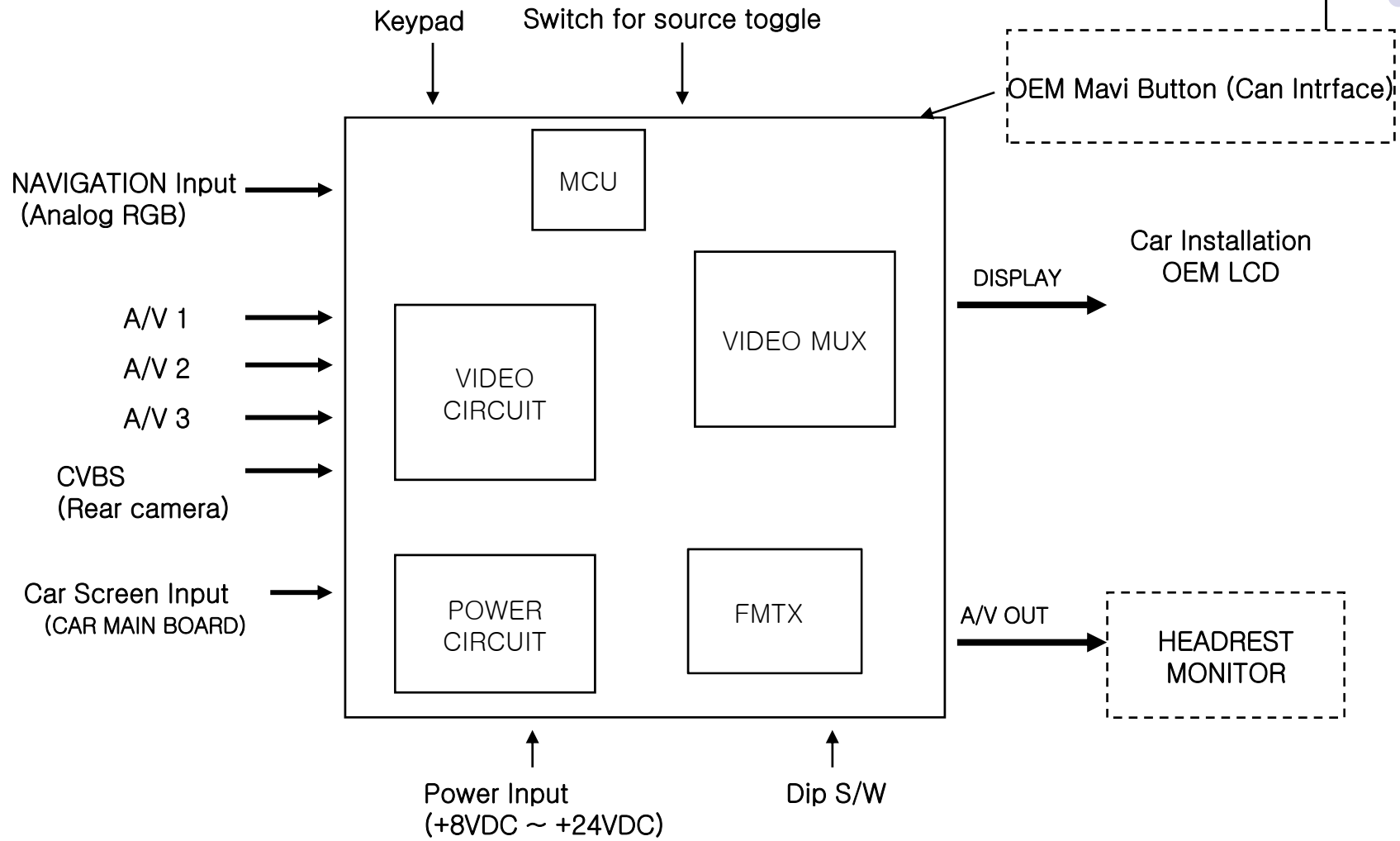
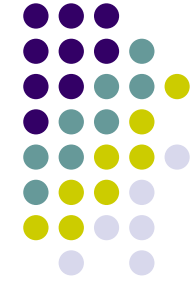

-Outline Dimension

155mm * 93mm * 20mm

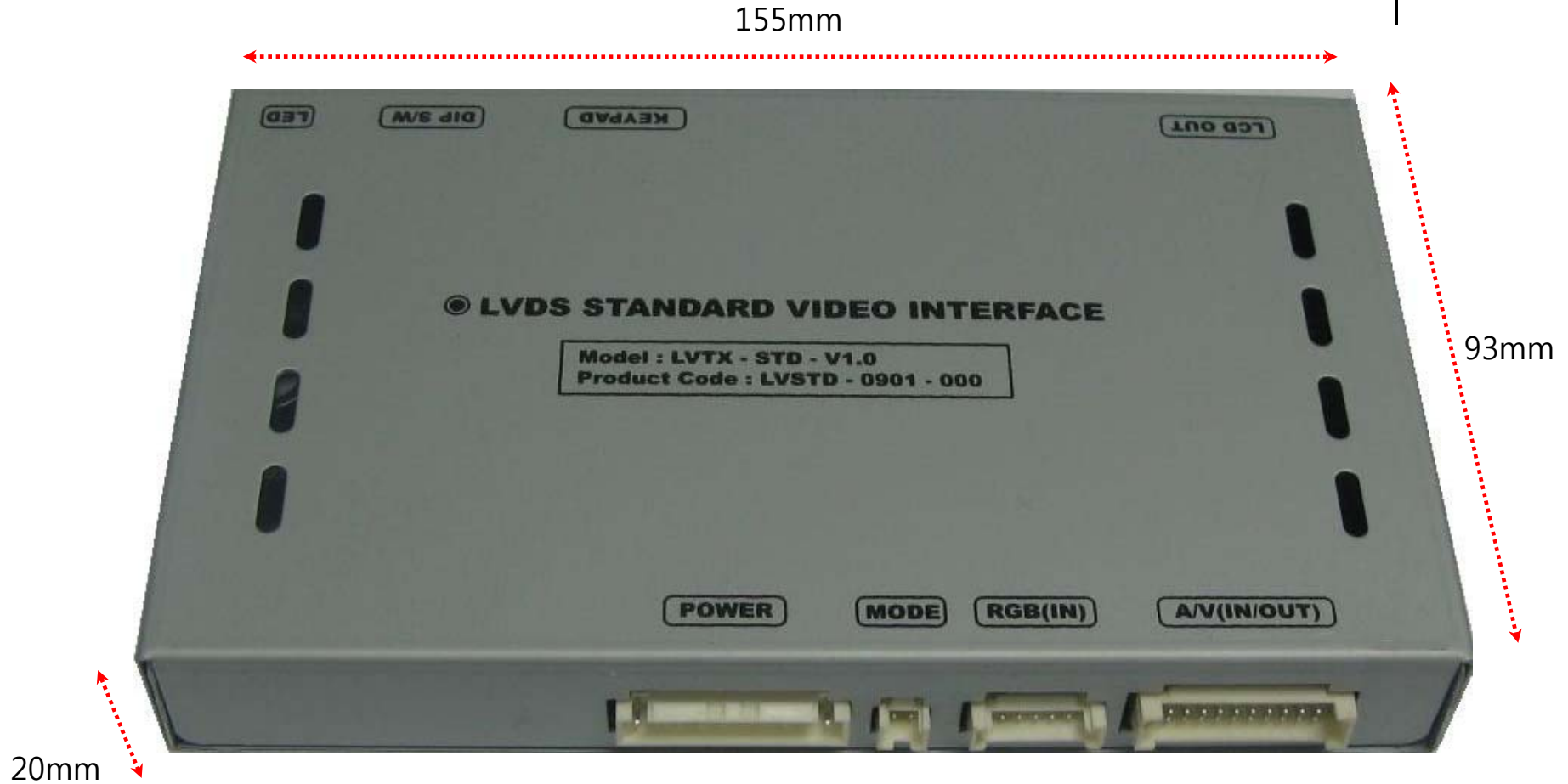

-External Appearance

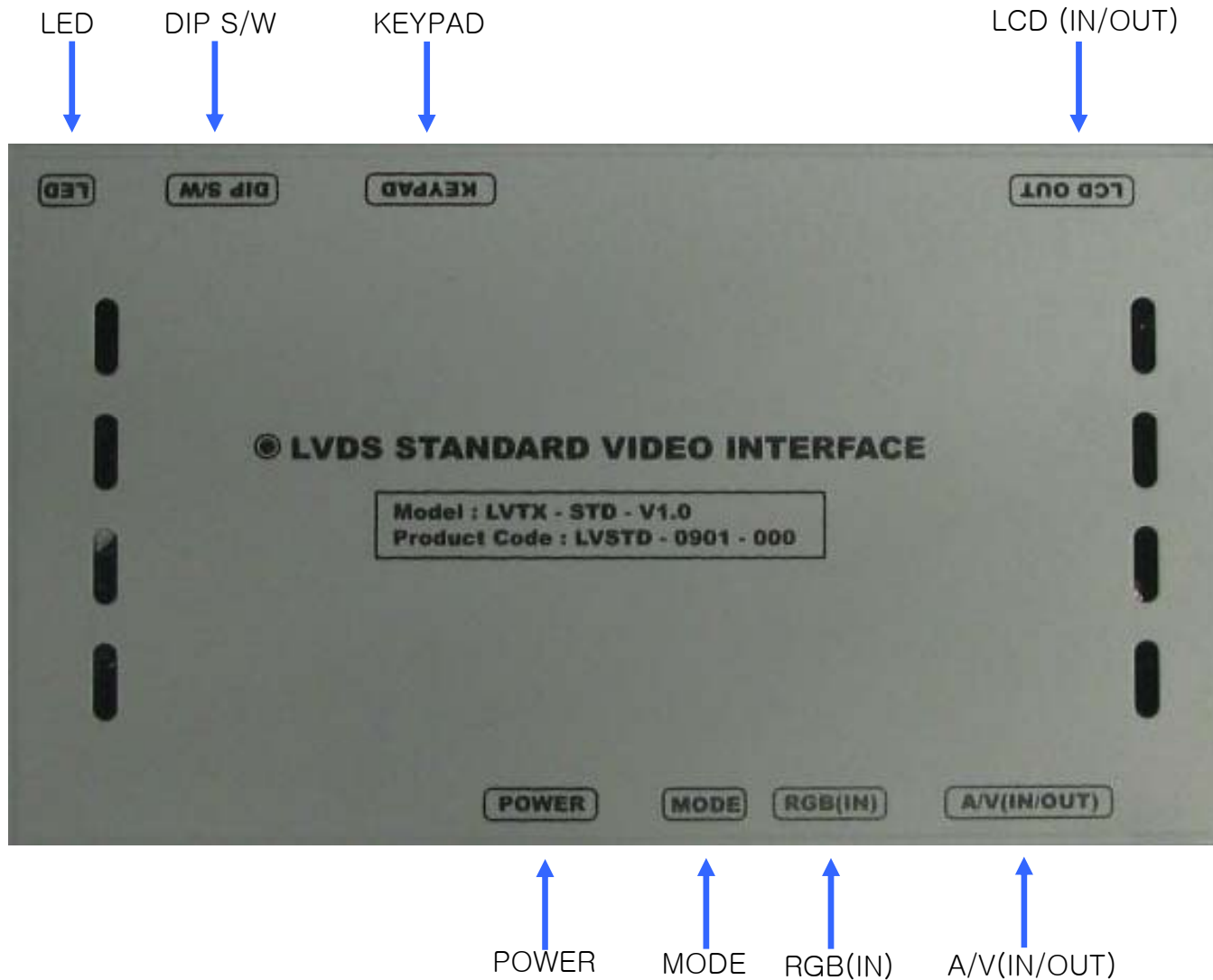

-External Appearance

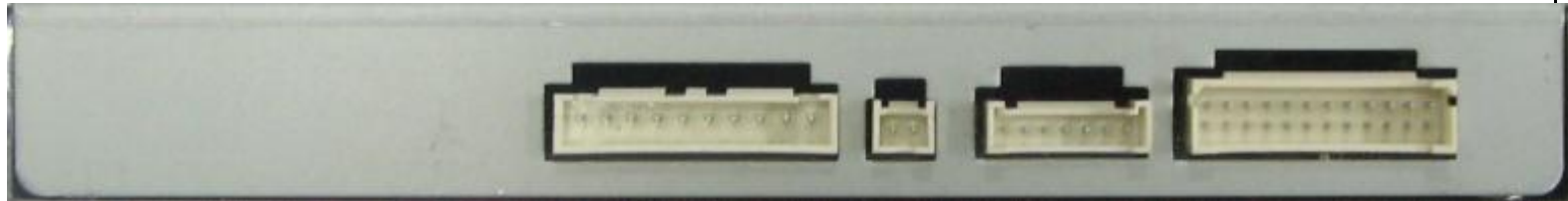

↑
Power

↑
MODE

↑
RGB(IN)

↑
A/V(IN/OUT)



↑
LCD (IN/OUT)

↑
KEYPAD

↑
DIP S/W

↑
LED

-Connector Pin Assignment

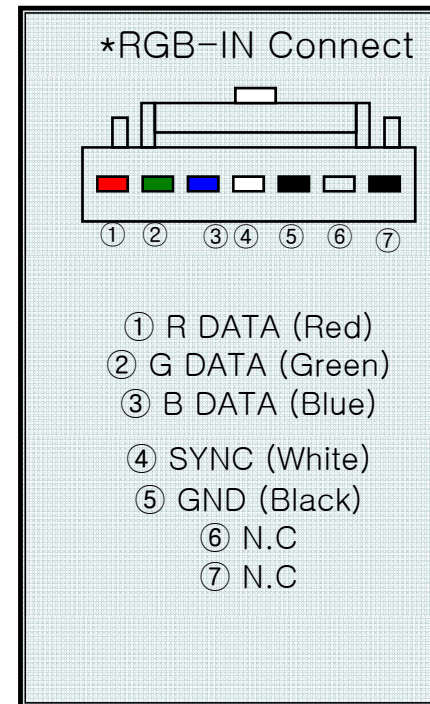
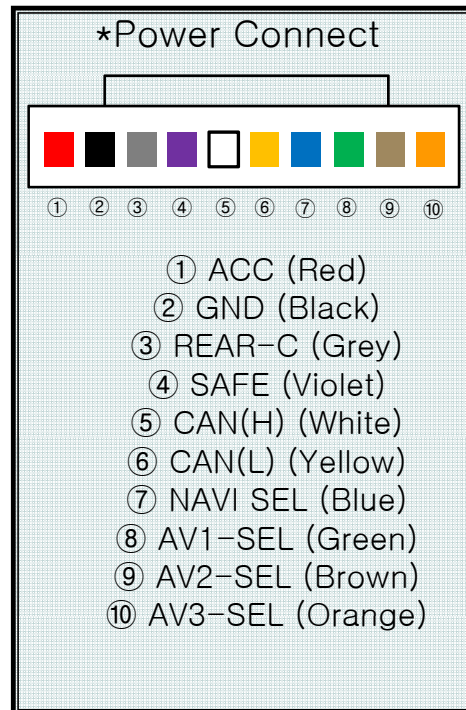

-Connector Pin Assignment

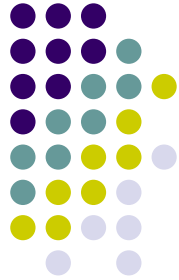

* Power Cable

FILTER & FUSE BOX

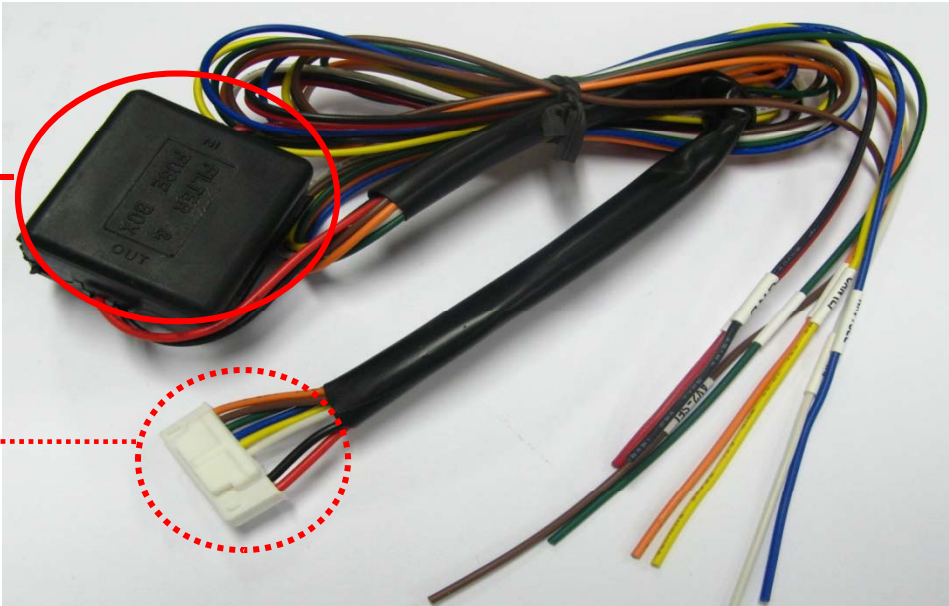

1m

-DIP SW Setting



※ ON : DOWN, OFF : UP ; Default : all OFF

#PIN	FUNCTION	DIP S/W Selection
1	RGB INPUT MUTE	ON : Skipping RGB Mode OFF : RGB Display
2	A/V 1 MUTE	ON : Skipping A/V 1 OFF : A/V1 Display
3	A/V 2 MUTE	ON : Skipping A/V 2 OFF : A/V2 Display
4	A/V 3 MUTE	ON : Skipping A/V 3 OFF : A/V3 Display
5		N.C
6		N.C
7		N.C
8	To select original NAVI	ON : Changing mode ; Main-Main-NAVI-AV1~3 (This is for original Navi) OFF : Changing mode ; Main-NAVI-AV1~3

※DIP S/W Use Example

- Use Input Mode : A/V2, A/V3
- Use original Navigation

- ▷ DIP S/W : 1,2 -> ON (INPUT MODE SKIP)
- ▷ DIP S/W : 3 -> OFF (enable A/V3)
- ▷ DIP S/W : 4 -> OFF (enable A/V3)
- ▷ DIP S/W : 5,6,7 -> OFF
- ▷ DIP S/W : 8 -> ON



-How to use remote



Dimension : 85 * 40 * 8 (mm)

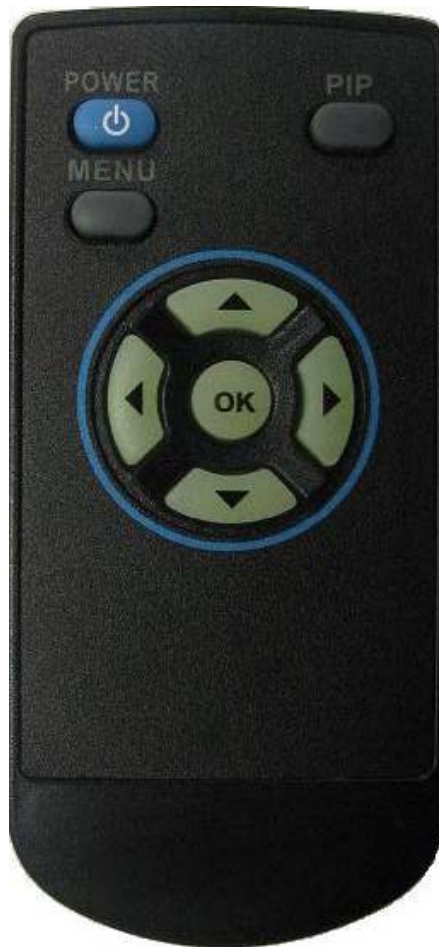

POWER

MENU : OSD Menu

OK : Select

▲ : Up

▼ : Down

◀ : Left

▶ : Right

*FACTORY MODE (Interface setting)
: Operated with pressing ▲ -> ▼ -> ▲ -> MENU
keys in the remote in sequence.

-OSD(On Screen Display)



- Analog RGB Mode

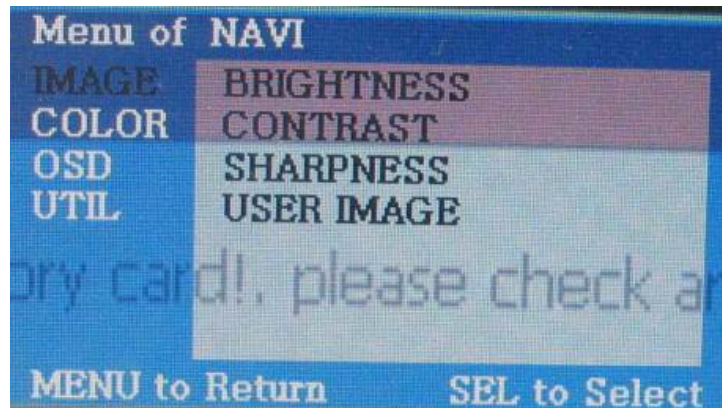

- Video Mode



IMAGE Menu

- BRIGHTNESS
- CONTRAST
- SATURATION
- HUE
- SHARPNESS
- USER IMAGE

OSD(On Screen Display)



- Analog RGB Mode
- Video Mode

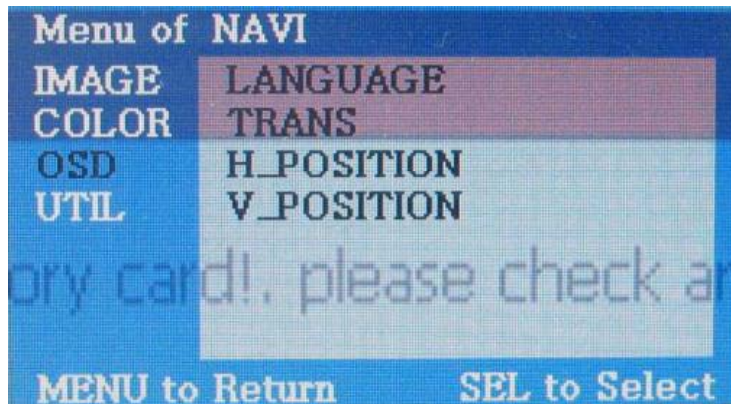

OSD Menu

- **LANGUAGE** : Language selection (only available in English)
- **OSD TRANS** : OSD window transparency setting
- **OSD H_POS** : Move of OSD window to Left, Right
- **OSD V_POS** : Move of OSD window to Up, Down

OSD(On Screen Display)



- Analog RGB Mode

- Video Mode

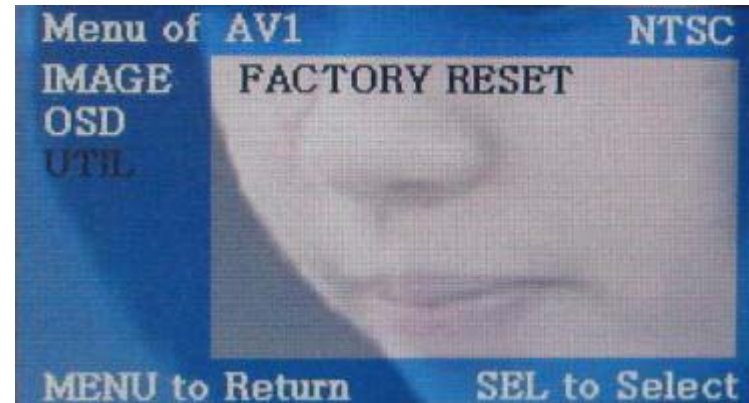
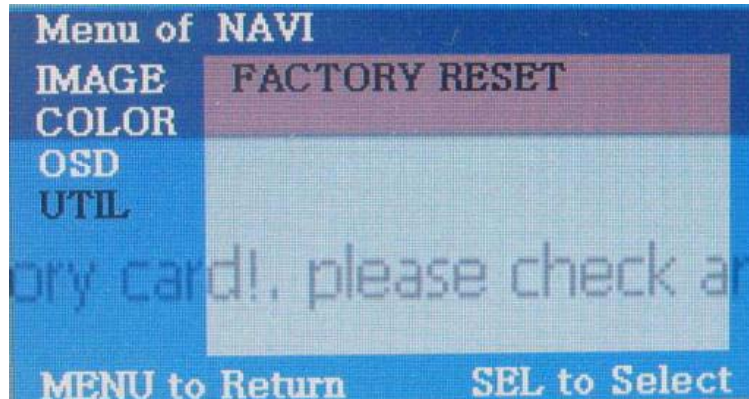

UTIL Menu

- **FACTORY RESET** : Initializing OSD setting value

OSD(On Screen Display)



- Factory Mode

- Operated with pressing ▲ -> ▼ -> ▲ -> MENU keys of the remote in sequence.

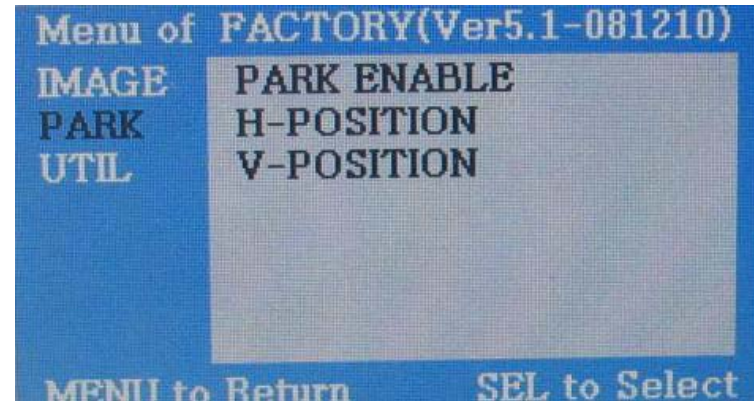
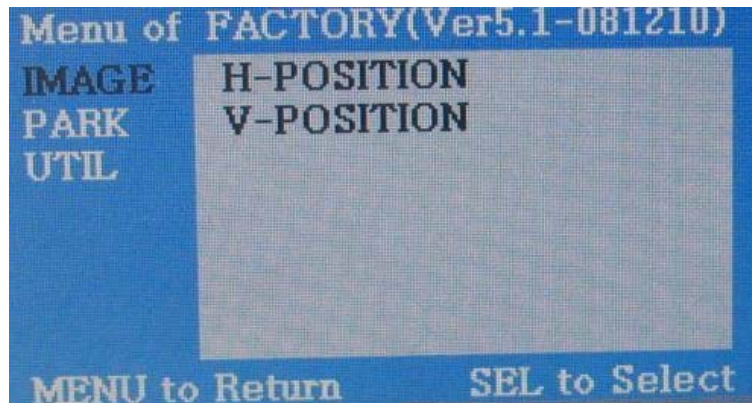

Factory Mode

- **IMAGE :**

- H-POSITION : Move of Screen to Left, Right
- V-POSITION : Move of Screen to Up, Right

- **PARK :** Referring to the page no. 21

OSD(On Screen Display)



- Factory Mode

-Operated with pressing ▲ -> ▼ -> ▲ ->MENU keys of the remote in sequence.

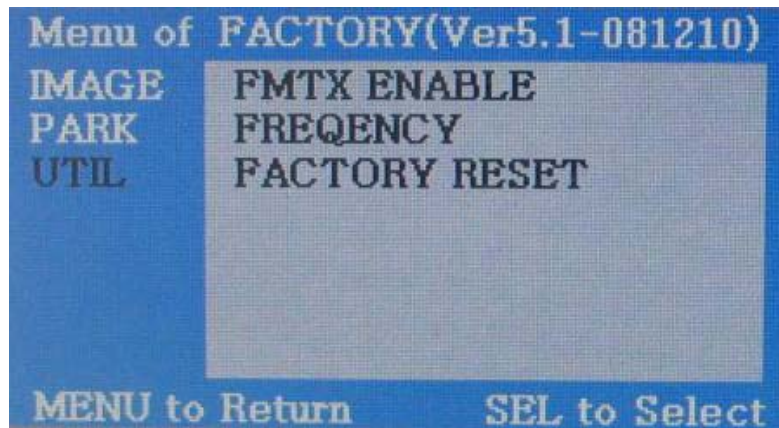

Factory Mode

- UTIL :
 - FMTX ENABLE : FMTX Setting
 - FREQUENCY
 - FACTORY RESET

-FMTX Frequency



Factory Default : FMTX USE – ON, FREQUENCY – 88.2MHz

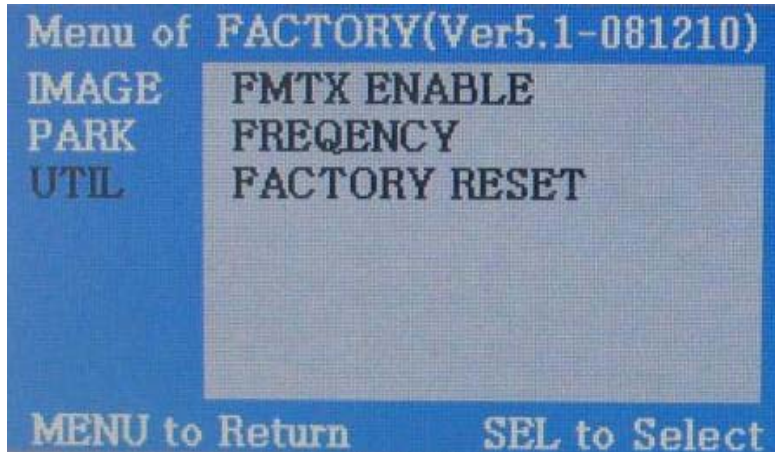

-Get the Factory Mode Operated with pressing UP->DOWN->UP->MENU keys of t he keypad in sequence

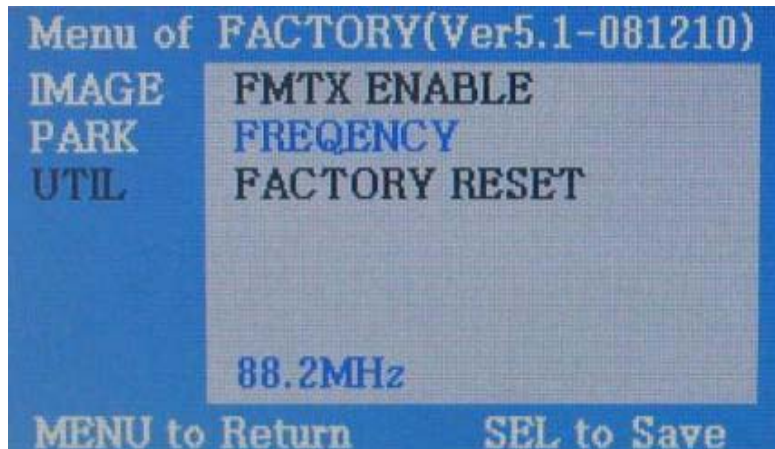

-Set "FM-TX USE" to "ON" like the left picture.
(“ON” is Default). control the frequency by “UP”, “Down” keys. At the bottom, you can see present frequency and control it from 87.5MHZ to 108MHZ. (1MHZ per each time to press)

※If you do not want this function, kindly set “FM-TX USE” to “OFF”

- How to use parking guide line



Factory Default : DISPLAY – ENSABLE

①

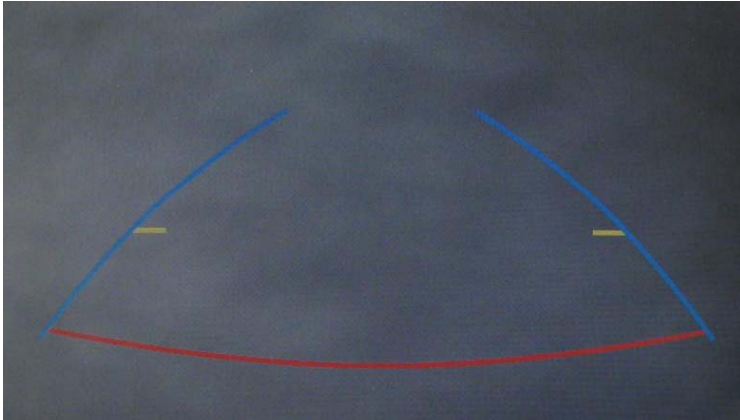

① Once putting the gear to reverse, the lines appears in the screen automatically.

②

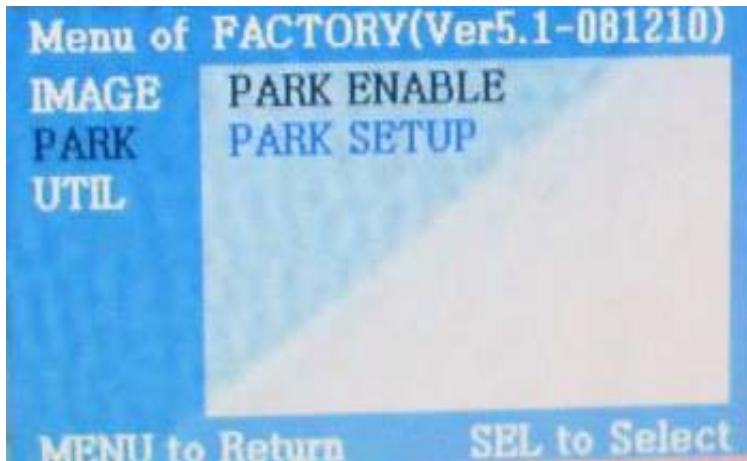

② When pressing ▲ → ▼ → ▲ → MENU buttons in sequence, OSD menu appears like left picture. At this, once selecting "PARK SETUP" with pressing 'OK' button in the remote, you can control distance between 2 parallel lines.

- How to use parking guide line



Factory Default –Types:0, H_Pos:50, V_Pos:120

③

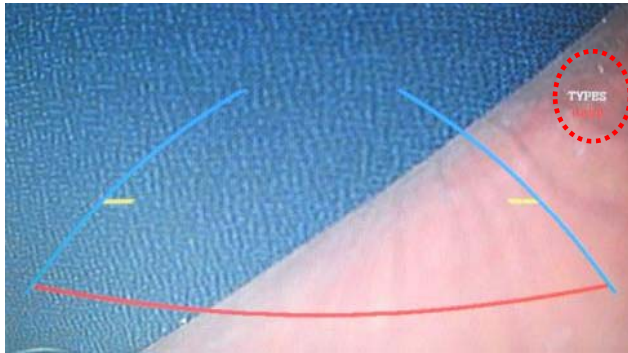

[Step. 0]

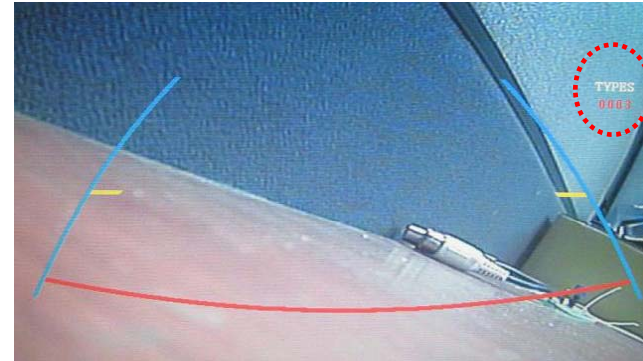

[Step. 4]

③ There are 4 steps of parallel lines distance, the distance is controlled by ▲, ▼ keys in the remote. After controlling, must press "OK" button to save this status. (You can see present status at the right in the screen)

④

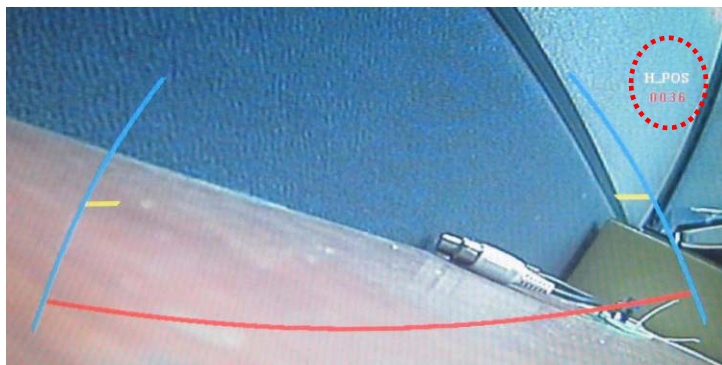

④ After Step. 3, press ▲, ▼ buttons of the remote to control left, right position with pressing 'OK' button, and then you can control up, down position

※ If you do not this function, kindly set 'PARK ENABLE" to 'OFF'

-Product Composition

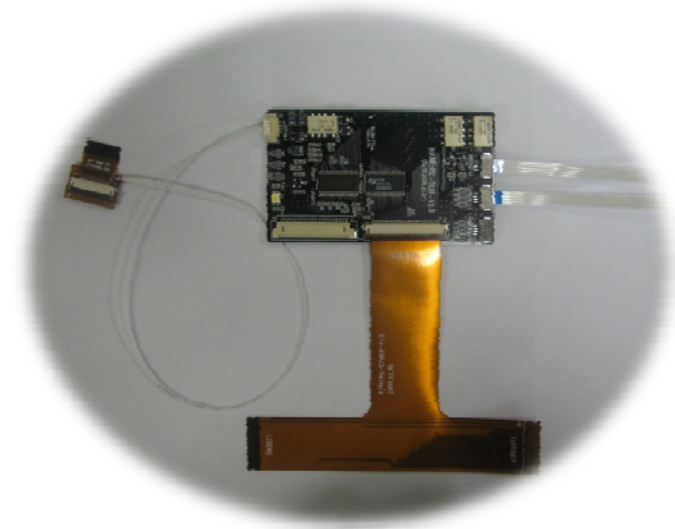

OSD Keypad Or Remote : 1 EA
LCD Cable : 1 EA
Navi Cable : 1 EA
Toggle S/W : 1 EA
Button Cable : 1 EA

Power Cable: 1 EA
A/V Cable : 1 EA
Ground or IR Cable : 1 EA
Sub-Board : 1 EA
FPC Cable : 1 EA

-Installation Structure

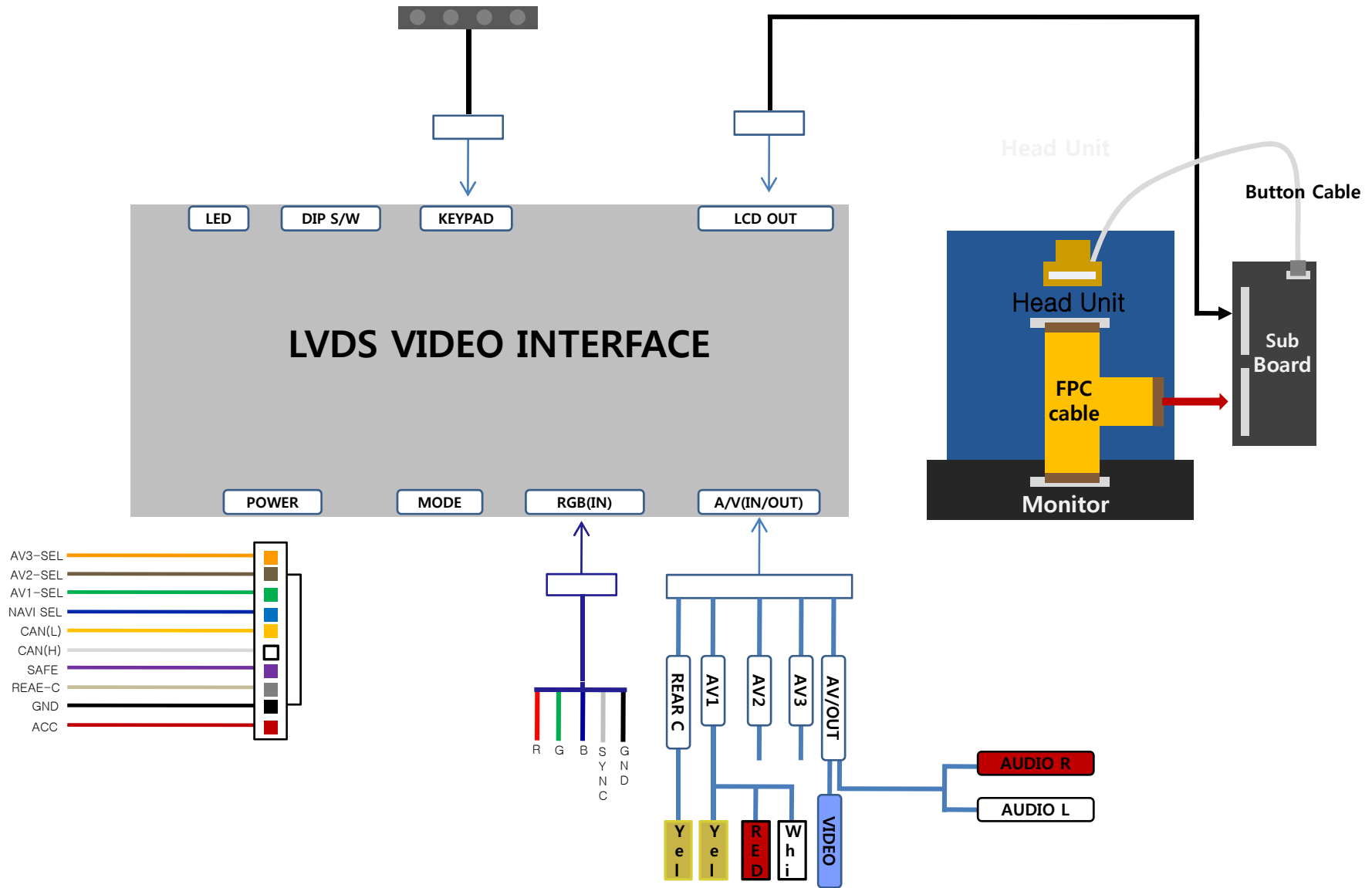

-FAQ



1. When can not change mode.
 - Check if the Ground (IR) cable is connected or not.
 - Check if LED lamp is turned on or not. If it is not turned on, Check if power cable is connected or not.
 - Check if CAN cables are connected well.

2. When the screen is displaying only black color.
 - Check if 2nd LED is turned on or not. If it is not turned on, please check all video sources that you will connect with the interface is operating well or not.
 - Check if interface is connected well.

3. When displayed color of screen is not proper. (If it's too dark or the color is not proper)
 - Try to select "Initial" on OSD menu, If the color of screen keeps on displaying wrong color, you have to ask manufacturer for the problem.
 - Try to adjust Color, Contrast, Brightness by the remote.

4. When Back-up camera is not displayed on the screen.
 - Put Dip S/W no.7 down.

5. When the mode you set is not skip.
 - Check if Dip S/W is set properly.

6. When Main screen on the car is not displayed.
 - Check if In/Out cables are connected well. If it keeps showing the same problem, you have to ask manufacturer for the problem.

7. When the screen is displaying only white color.
 - Check if out cable is connected well. If it keeps showing the same problem, you have to ask manufacturer for the problem.