

Release date : 2011.07.04
Model : QVL-GF08-V7 / Product code : GF08-1106-004

GVIF Interface – v7 for Nissan & Infiniti Specification

Contents

1. Before installation

1.1 Main specification	3
1.2 Features	4
1.3 System diagram	5
1.4 Components	6
1.5 Exterior	7

2. Setup

2.1 DIP switch	8
2.2 Remote controller	9
2.3 OSD Menu (On Screen Display)	10
2.4 FACTORY Mode (MENU for Installers)	11
2.5 Rear view parking guide line	12

3. Installation

3.1 Installation diagram	13
3.2 Cautions on installation	14
3.3 Example of installation in Nissan Patrol	15

4. Troubleshooting

5. GVIF (LVDS IN/OUT) cable problem	17
-------------------------------------	----

1.1 Main Specification

1. Input Spec. (MULTI VIDEO INTERFACE)

- 3 x **A/V Input** (for external video source – TV, DVB-T, DVD; **Auto detection NOT supported**)
Supports only NTSC for Nissan and Infiniti
- 1 x **REAR-C Input** (for external rear camera source; **Auto detection NOT supported**)
Supports only NTSC for Nissan and Infiniti
- 1 x **Analog RGBCs Input** (for navigation system)
- 1 x **GVIF Input** (LVDS input)

2. Output Spec.

- 1 x **GVIF Output** (LVDS output)
- 3 x **Audio Select** (12V power comes out from 3 wires by AV1, RGB & REAR modes – **MAXIMUM power available for each channel is 500 mA!!!**)

3. Power Spec.

- Input Power : 8VDC ~ 18VDC
- Consumption Power : 6WATT, Max

4. Switch Input mode

- Input video DISABLE function: Possible to disable each input by operating Dip S/W.
- Possible to switch input mode with Keypad
- Possible to switch input mode with switch for source toggle

1.2 Features

- Improved High-definition.
- Supports **only** NTSC.
- Remote controller offered.
- Possible to move the displayed position of AV, Navigation.
- Able to run OSD menu without image displayed.

1.3 System Diagram

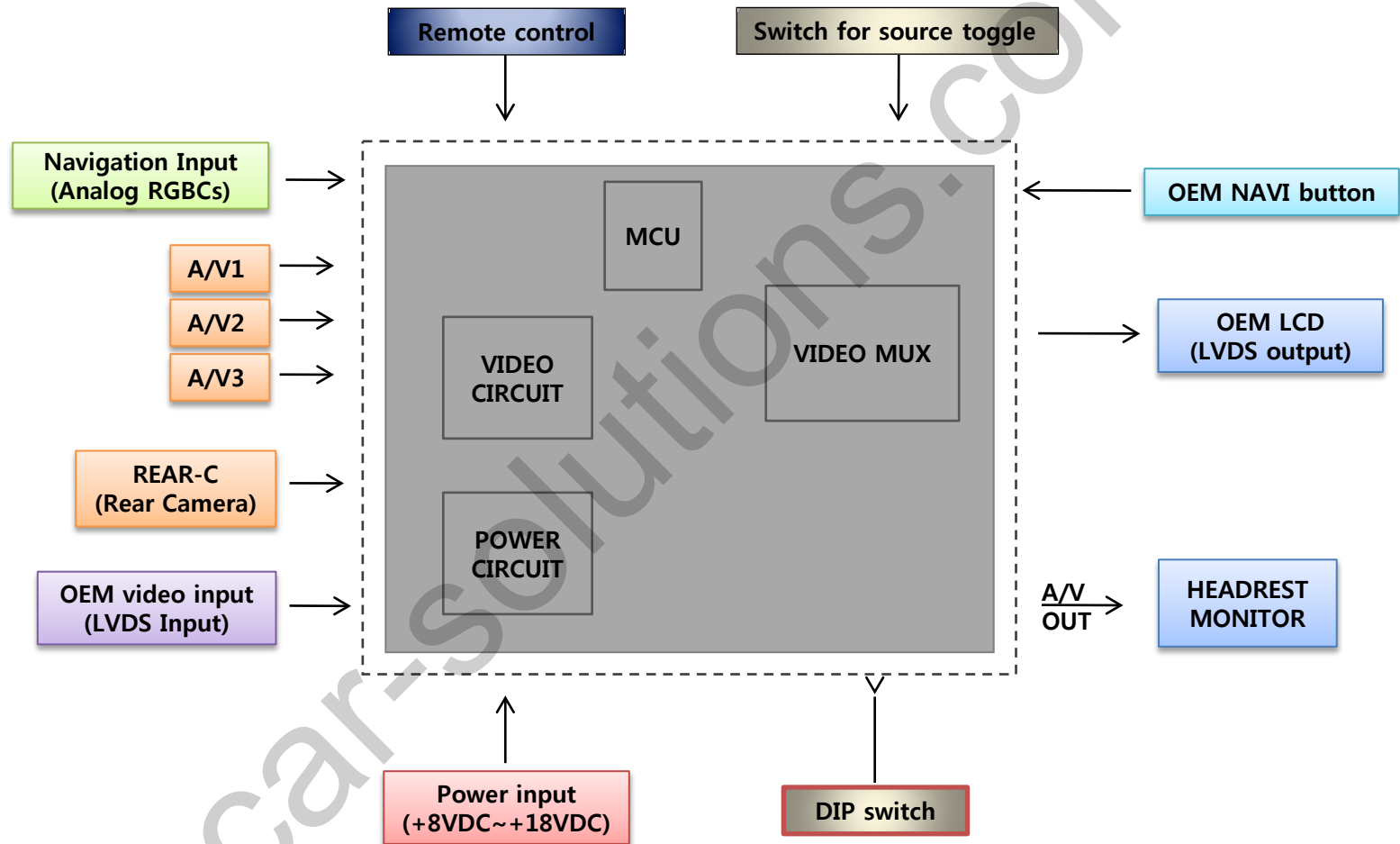

1.4 Components

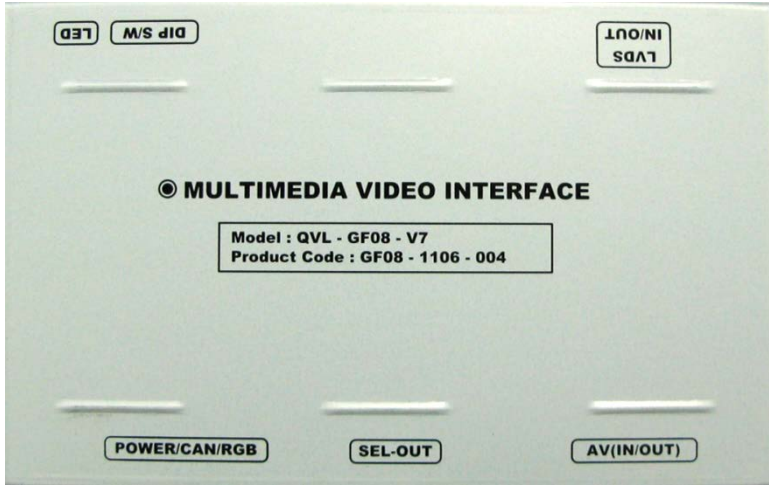

Main board * 1pc.



MODE cable * 1pc.

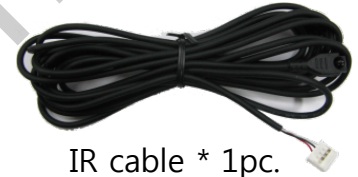

IR cable * 1pc.



AV cable * 1pc.



Nissan/Infiniti cable * 1pc.

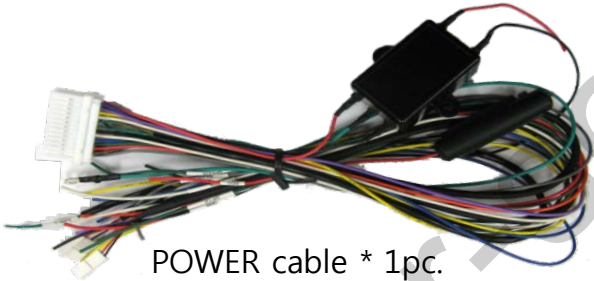

POWER cable * 1pc.



SEL cable * 1pc.



RGB cable * 1pc.



Remote control * 1pc.

1.5 Exterior



Dimension

Horizontal length 139mm
Vertical length 87mm
Height 24mm

- ① POWER/CAN/RGB
- ② SEL-OUT
- ③ AV(IN/OUT)
- ④ LVDS IN/OUT
- ⑤ DIP S/W
- ⑥ LED

2.1 DIP switch

DIP #	Function	DIP S/W selection
1	RGB Input	ON : RGB Input is OFF OFF : RGB Input is ON
2	A/V1 Input	ON : AV1 Input is OFF OFF : AV1 Input is ON
3	A/V2 Input	ON : AV2 Input is OFF OFF : AV2 Input is ON
4	A/V3 Input	ON : AV3 Input is OFF OFF : AV3 Input is ON
5	Car Model	ON : NISSAN / INFINITY cars OFF : NOT USED
6	OEM Video Input	ON : OEM input is OFF (<i>OEM GVIF input</i>) OFF : OEM input is ON (<i>OEM GVIF input</i>)
7	Rear Mode	ON : External Rear Camera OFF : OEM Rear Camera
8		NOT USED

※ ON : DOWN, OFF : UP

[NISSAN]

-Input mode to be used: MAIN + A/V3
-Rear view camera: installation on REAR-C

- ▷ DIP S/W : 1 → ON (INPUT MODE SKIP)
- ▷ DIP S/W : 2 → ON (INPUT MODE SKIP)
- ▷ DIP S/W : 3 → ON (INPUT MODE SKIP)
- ▷ DIP S/W : 4 → OFF (A/V3 available)
- ▷ DIP S/W : 5 → ON
- ▷ DIP S/W : 6 → OFF
- ▷ DIP S/W : 7 → ON (REAR-C available)
- ▷ DIP S/W : 8 → OFF



2.2 Remote controller

Buttons	Function
POWER & PIP	NOT USED
MENU	OSD Menu
OK	Making a selection
▲	Move UP
▼	Move DOWN
◀	Move LEFT <i>(or press 2 sec. - Factory mode)</i>
▶	Move RIGHT <i>(or press 2 sec. - Factory Reset)</i>



2.3 OSD (On Screen Display)

OSD menu: Press "MENU" button on the remote control.

Analog RGB MODE

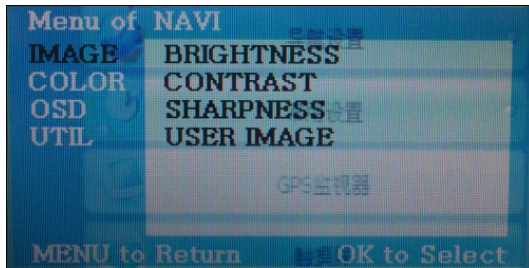

Analog RGB MODE



Analog RGB MODE



Video MODE



Video MODE

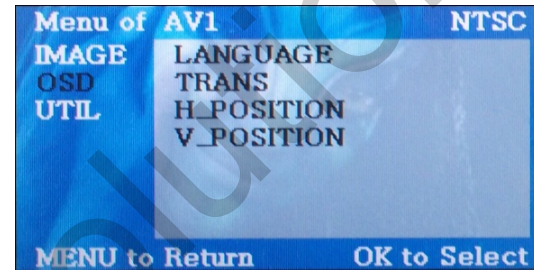

Video MODE



IMAGE

- BRIGHTNESS
- CONTRAST
- SATURATION
- HUE
- SHARPNESS
- USER IMAGE : To choose a option among 4 prepared color shades.

OSD

- LANGUAGE : To change the language displaying on navigation, DVD, CMMB OSD menu (select 1 among English or Chinese)
- TRANS : Transparency control of the OSD background
- H_POSITION : Horizontal movement of the OSD window
- V_POSITION : Vertical movement of the OSD window

UTIL

- FACTORY RESET : To reset all the values about navigation, DVD screen to factory default. (NOT available for reset of the position value of images, only for functions inside OSD menu)

2.4 Factory mode

Factory mode: Press ◀ button 2 seconds.

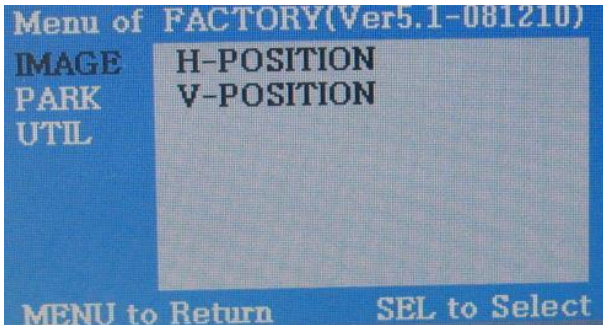

IMAGE

- H_POSITION : Horizontal movement of the OSD window
- V_POSITION : Vertical movement of the OSD window



PARK

- PARK ENABLE : Setup of rear view parking guide line
- PARK SETUP : Control over position of rear view parking guide line.
(Refer to page 12)
- SAFE ENABLE : To select whether to use SAFE function (NOT to allow watch video while driving) or not.

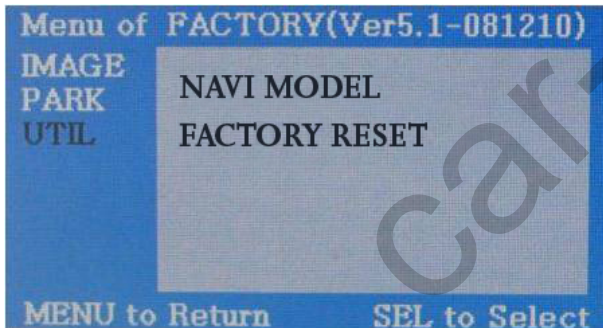

UTIL

- NAVI MODEL: Default – for Navigation unit with resolution 480x234 (400x234)
NAV N GO – for Navigation unit with resolution 480x234 (400x234)
KD680_NEW – for Navigation unit with resolution 800x480
- FACTORY RESET: To reset all the value in factory mode

2.5 Rear view parking guide line

Factory mode: Press ◀ button 2 seconds.

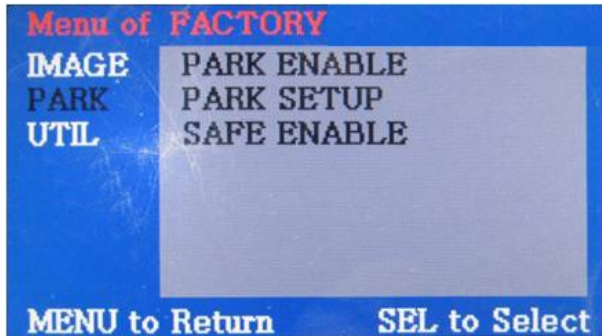

① Register the value needed on the "PARK ENABLE" as "ON" in the PARK section as shown left. **(default is ON)**

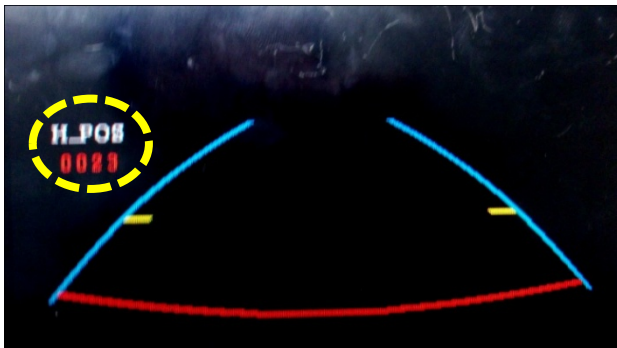

② If you get rear gear after setup, parking guide line will appear on screen as shown left. Now that you push "OK" button, you can see "H-POS" on the left of screen. Then adjust horizontal position of the guide line.

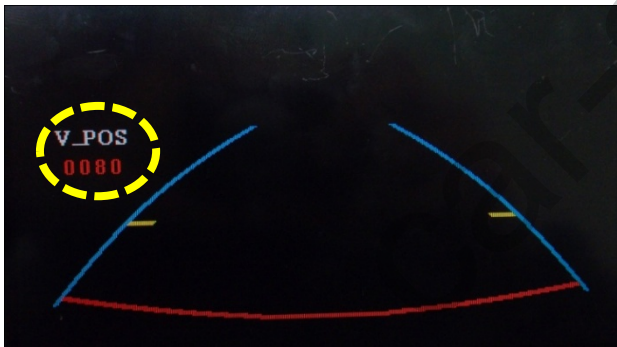

③ After adjusting horizontal position, press "OK" on the remote controller. Then you can see "V-POS" on the left of screen. At that time you can adjust vertical position of the guide line.

3.1 Installation diagram

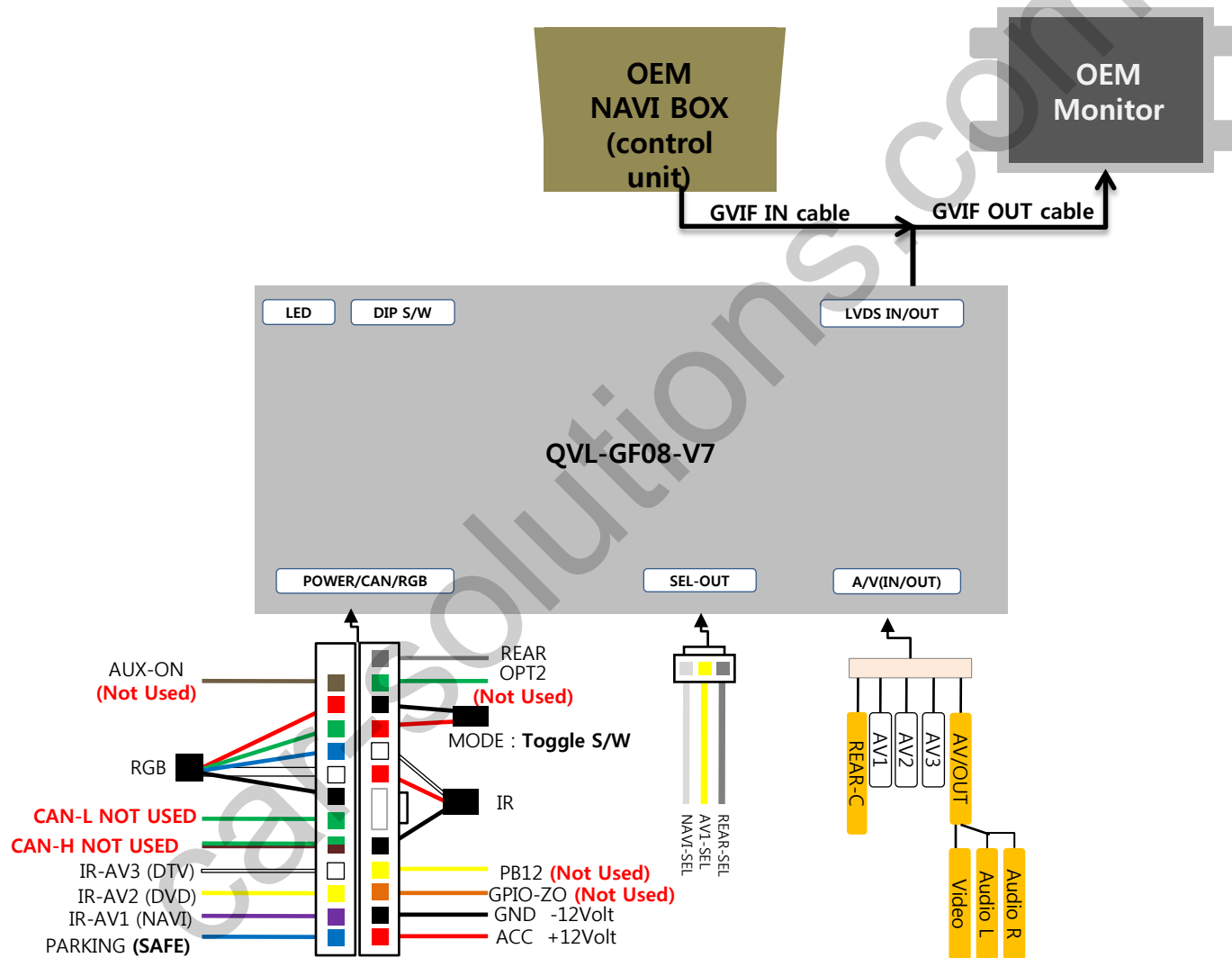

3.2 Cautions on installation

- Ignition key should be taken off before starting installation, interface power connection must be the last step in installation.
- Power cable should be separated when connecting interface.
- Should be no any electronic devices or magnetic pole around installation place.
- All steps of installation should be done by well-trained specialist.
- Dismantling without manufacturer's permission can not be guaranteed, (No permission to break attached label on the board.)
- Kindly check all parts are in the box, when receiving the product, if anything missing, inform to the supplier or manufacturer.
- According to our sales policy, any problems caused by user mistake, careless can not be guaranteed.

3.3 Example of installation in Nissan Patrol

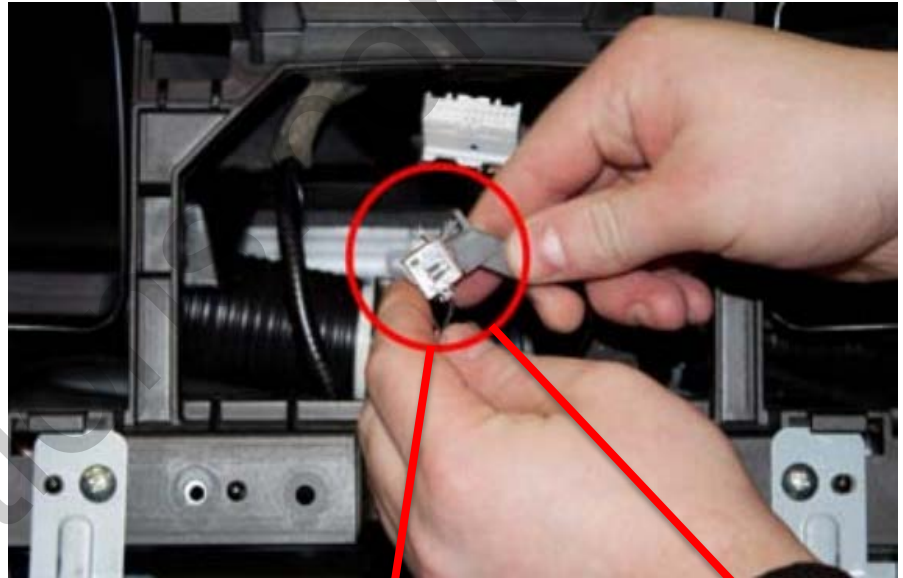
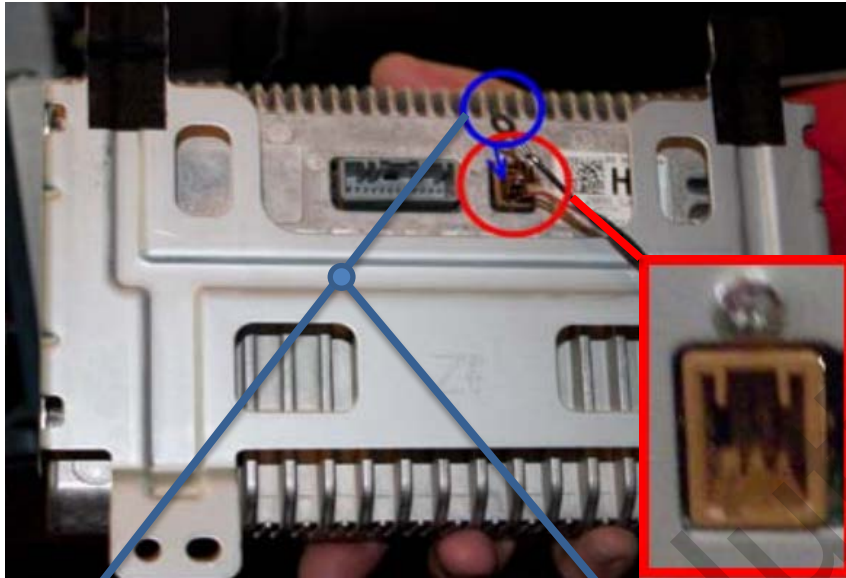

WARNING!

Connect ring terminal to display framework in order to remove signal potential difference between video interface and OEM car display



4. Troubleshooting

Q. I can not switch A/V sources.

A. Check IR or Ground cable connection. Check LED lamps in the interface, if it is not on, check power cable.

Q. All I got on the screen is black.

A. Check second LED lamp of the interface is on, if not, check A/V sources connected are working well.
(Second lamp indicates AV sources connected works well.) Check interface connection has been done well.

Q. Displayed image color is not proper.

A. Try to select "INITIAL" in OSD menu if it does not work, inform the manufacturer.

Q. Rear camera image does NOT appear.

A. Set DIP switch #7 in "ON"

Q. Unwanted A/V mode is displayed. (A/V source switching order : OEM->RGB->AV1->AV2->AV3)

A. Check DIP Switch Setting.

Q. OEM image is not displayed.

A. Check interface LVDS In/Out cable connection. Swap RED and WHITE wires in LVDS IN/OUT cable

If the status keeps on, inform the manufacturer.

Q. Screen only displays white like left picture.

A. Check LCD out cable is connected well, if this status keeps, inform the manufacturer.

5. GVIF (LVDS IN/OUT) cable problem

PROBLEM: GVIF output doesn't work



SOLUTION: Swap the WHITE and RED wires in LVDS IN/OUT cable

