

FN-MAZDA3

Installation Manual



2015 NEW MAZDA

Add GPS Navigation+2AV Inputs+1CAM
Add Reverse Camera with Dynamic Guidelines

Suitable models:

MAZDA 2	MAZDA 6	MAZDA CX-9
MAZDA 3	MAZDA 8	MAZDA BIANTE
MAZDA 5	MAZDA CX-5	MAZDA MX-5

Product Name: FN-Mazda3

Product Type: Interface with build in navigation

Application: All Mazda 2014/2015 cars with new Mazda Connect systems

What's in the box:



Item	Qty	Description	Part No.
1	1	Navigation Interface	
2	1	Power Interface Harness	
3	1	Audio RCA Cable	
4	1	Video RCA Cable	
5	1	LVDS Cable	
6	1	Relay Interface Cable	
7	1	Speaker	
8	1	GPS Antenna	

Description:

This interface is used to install navigation, reverse camera and 2 other video inputs onto the car screen. It has 4 video inputs:

1. RGB port (External navigation or External Android box).
2. Video In1 (used for DVD, Digital TV, DVR etc).
3. Video In2 (used for DVD, Digital TV, DVR etc).
4. CAM In (used for reverse camera).

Functions:

This interface is complete plug and play. All connectors are easy to install. It has built in high speed navigation module which is compatible with all new navigation software's like IGO, Sygic etc.

OEM touch screen can be used to control the navigation. User do not need to open screen to add PCB or touch overlay.

OEM "call off" button can be used to switch between video sources.

Easy installation, few parts and OEM connectors make this product ideal for users.



OEM touch screen will be used to control the navigation.



The "CALL-OFF" button on the steering wheel is used to switch between video sources.

Connections Diagram:



How to connect Power cable:

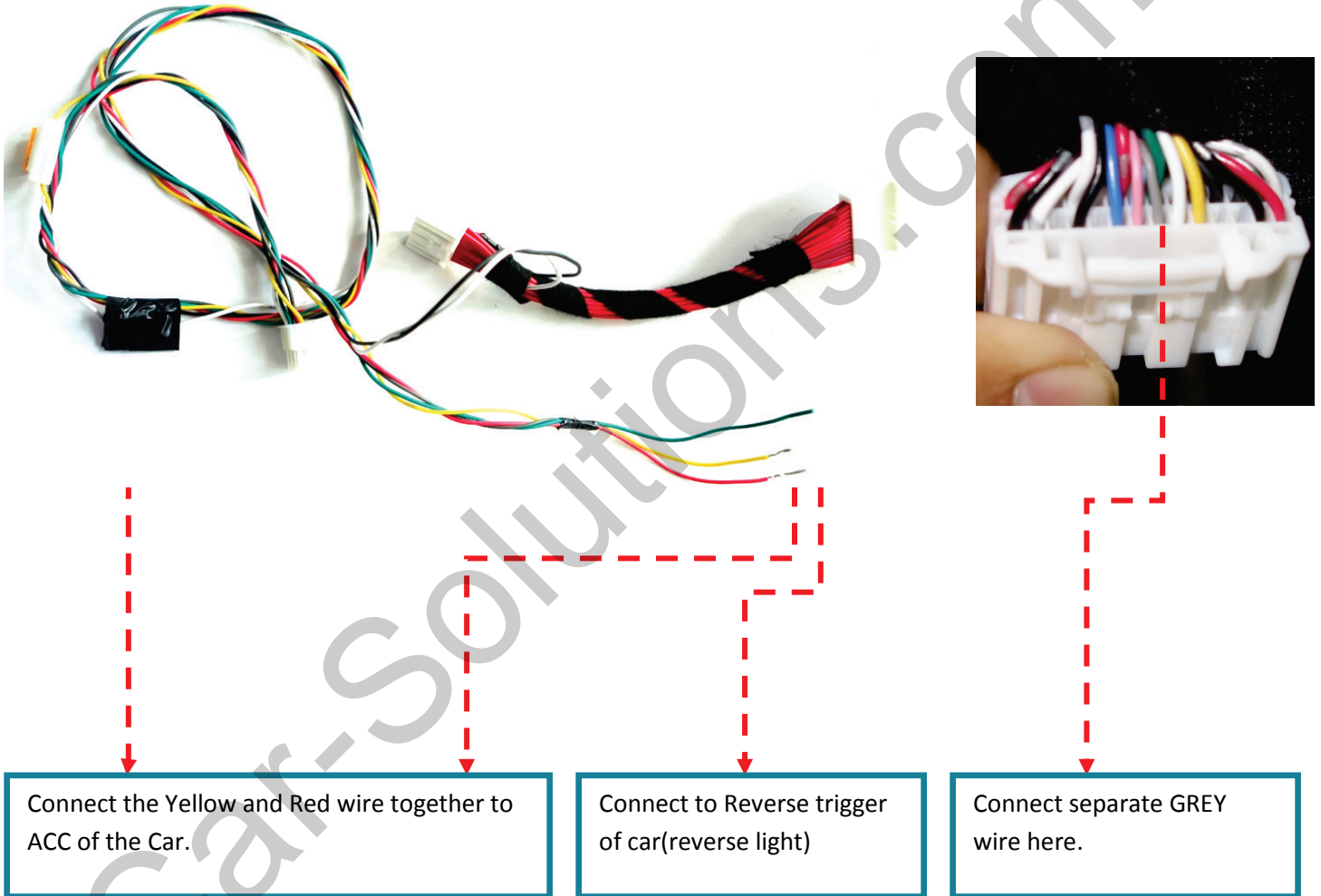

RGB Port:

The RGB port can be used to connect external GPS module. Can also be used to connect external Android Box (provided as optional). The Android box has powerful hardware and customized UI for optimized use in a car while driving.



The Camera can be connected using the Video RCA cable provided.

- Red: Backup camera Input.
- Yellow: Video Input 1.
- White: Video Input 2.
- Grey: IR output to control inserted DVD/TV touch control.



DIP Settings:

DIP Down= ON		DIP UP= OFF	
DIP	ON	OFF	Default
1	External RGB connected. (when using external GPS/Android box)	Internal GPS module Enabled.	UP(OFF)
2	External video source 1 enabled (DVD/Digital TV etc)	External video source 1 Disabled	UP(OFF)
3	External video source 2 enabled (DVD/Digital TV etc)	External video source 2 Disabled	UP(OFF)
4	RGB Input Resolutions 800*480	RGB Input Resolutions 480*240 or 400*240	DOWN(ON)
5	Reverse camera installed	Reverse camera not installed	DOWN(ON)
6	Set On Once for IR programming and ON/OFF 5 times for touch panel calibration	Set off for normal use (touch calibration is for DVD/TV for Video1 and Video2)	UP(OFF)
7,8	No Function (Keep UP(OFF) in all cases)		

Power Definition for 6PIN power connector between CANBOX and Interface:

YELLOW: 12V power supply (Battery)

RED: ACC (=12V when key in ignition state) : when=12V, the interface works.

BLACK: Ground to Chassis.

GREEN: Can box generated reverse trigger signal [when =12V the reverse video is enabled], this wire is automatically generated by CAN bus.

WHITE: This wire is the switch signal, when the user presses call off key. Can switch video source.

GRAY: CAN box's communication data with guideline angle.

OSD Menu Operation:

The OSD Menu can be brought up by using the three buttons on the interface.

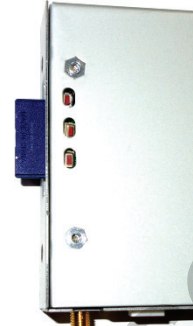
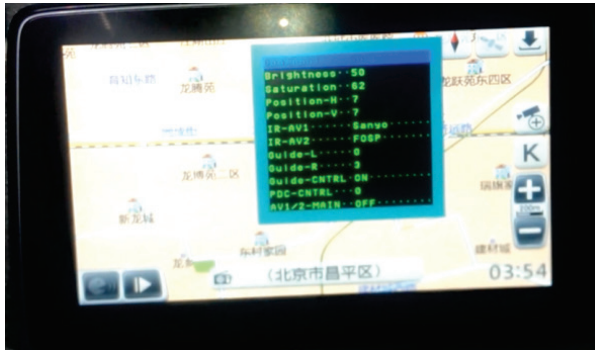

Each Video input i.e. GPS, Video1, Video2, Camera and RGB can be adjusted separately. The interface has 5 separate memory states for each setting.

The keys used are "menu" "+" and "-".

To bring up the OSD menu press the "menu" button. To toggle between option use "+" and "-".

Options:

- Contrast: Set the contrast of each video source.
- Brightness: Set the Brightness of each video source.
- Saturation: Set the saturation of each video source.
- Position-H: Set the horizontal position of each video source.
- Position-V: Set the vertical position of each video source.
- IR-AV1: Use this to IR program the touch control of video source 1.
- IR-AV2: Use this to IR program the touch control of video source 2.
- Guide-L: Use this to set horizontal position of guidelines on the screen.
- Guide-R: Use this to set horizontal position of guidelines on the screen.
- Guide-CNTRL: Use this to turn ON/OFF Parking Guidelines.
- PDC-CNTRL: Use this to turn ON/OFF PDC.

Extra Control Port:

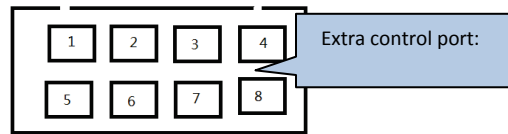
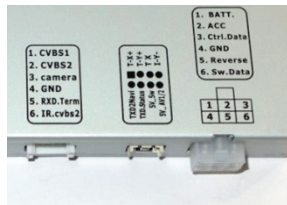

This interface has released a lot of hidden functions, so the 3rd party can use it for various usages.

The Extra control port close to the power connector:

- (1) the 4-pin in the up row : touch screen 4Pin input, when in DVD or TV, the touch foil can be switched and connected to these 4Pin, so the controller inside can read the touch operation and location and generate the IR code for DVD etc.
- (2) the 5th Pin(TXD2Navi) : the input pin to take external control data for internal navi, to replace the touch control.
- (3) the 6th Pin (TXD.Status) : the interface tells the outside its internal status.
- (4) the 7th Pin (5V_SW) : this pin can output 5V with 1A max, which is enough for a relay pull, when in inserted video this pin=5V, when in OEM video, this pin=0V.
- (5) the 8th Pin (5V_AV1/2) : this pin can output 5V with 1A max, which is enough for a relay pull, when in AV1/2 video this pin=5V, otherwise this pin=0V. it can be used to switch the 4Pin touch so one touch foil is shared by navi, and DVD/TV.

The 5th pin in the Video input port (RXD.Term)

This interface can work in terminal mode, a 3rd developer or installer can send commands into this pin. E.g. when he sends “switch Input 1\r”, the interface will switch into RGB navi, “switch Input 2\r”, the interface will switch into AV1, when he sends “Help\n” , the interface will tell a list of available commands. This Pin works in 11.5K baud rate and it loses all sent commands when drops power.

Parameters:

No.	Name	Parameter
1	RGB Navigation resolution	800*480 HD suggested.
2	Video source 1, Video Source 2, Reverse Camera	0.7Vpp with 75 ohm impedance NTSC/PAL/SECAM automatic switch
3	GPS antenna	5V active antenna from the golden finger connector
4	Reverse control wire	>5v will switch it to camera mode. All wires can tolerate 12V for <10 seconds.
5	Normal Power consumption	4.8W
6	Standby current	< 10uA
7	Reverse trigger threshold	>5V trigger
8	Work temperature	-40°C to +85°C
9	Dimensions	15.2*9.0*2.1cm
10	USB	OTG function, 1A output with surge of 3A.
11	Compatible maps	IGO, Sygic, Navitel, Navione etc.
12	HDMI Resolution for RGB port	800*600, 1024*768, 1280*720, 1920*1080 etc Auto recognition software built in.

Navigation Functions:

When switching to navigation the main menu will be shown.

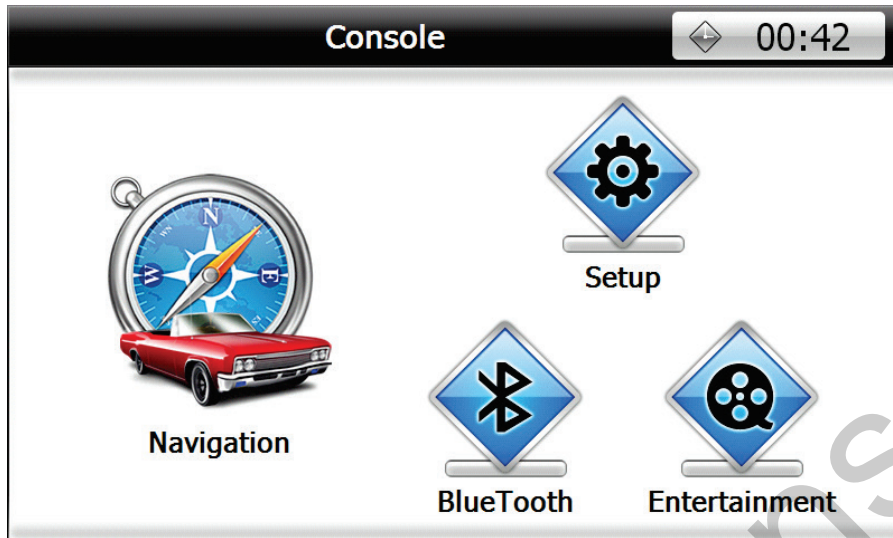

To setup up navigation press the "Navigation" icon. If first time use it will take you to page where user can select default path for the navigation software through the SD card. Select the ".exe" file for the navigation software. Select auto-start option if user do not want to set every time. This will execute the ".exe" file path on entering Navigation mode.

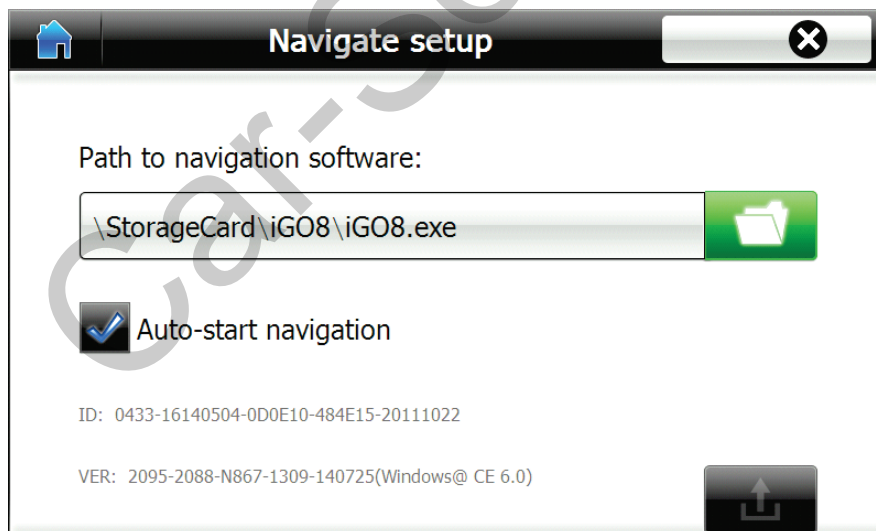

When starting for first time. Remove SD card and enter navigation mode. It will automatically start touch screen calibration. Press the corresponding crosses on the screen to complete touch calibration.

The main menu consists of three icons. Navigation, Setup and Multimedia.

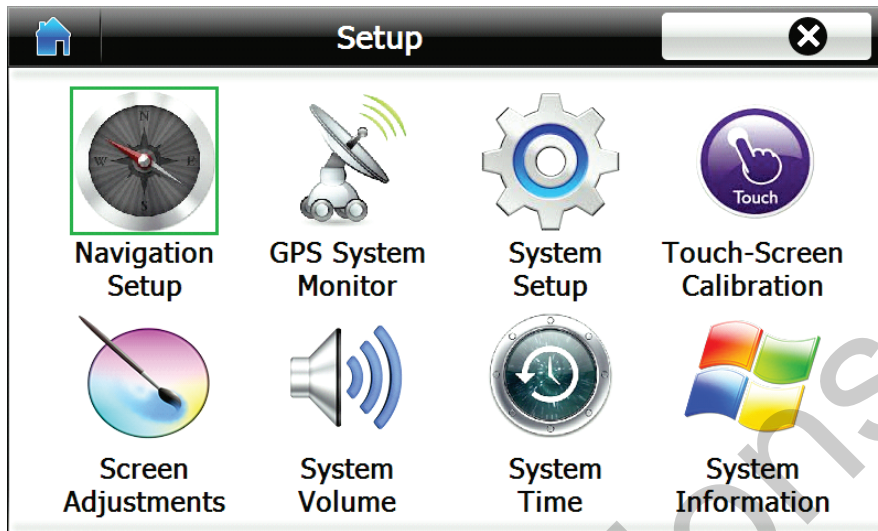

The Setup Icon will let you go to options menu. Which will let you configure options of the navigation module. The options consist of:

- Setup: set pathway for .exe file.
- GPS monitor: Used to check the GPS signal. If no signals shown set COM port to COM2. The Baud rate is automatically set.
- System Setup: Used to change the display language and switch effects.
- Touch Screen Calibration: To manually start touch screen calibration.
- Screen Adjustments: To set color, Position and Size of display. (will not be used in case using built in GPS module)
- System Volume: To adjust volume of touch strokes and system volume.
- Time settings: To adjust time and time zone. (will be selected automatically when GPS signal is positioned)
- System Information: To see software version, perform factory reset or Repairs.

Multimedia can be accessed from the main menu. This includes music, video, digital books, photos and Bluetooth music. The audio is sent out through AUX port and can be connected to the cars OEM speaker system. The files for multimedia are stored on usb and can be accessed using mini USB to USB hub cable. The functions of multimedia are used through the touch screen.



- For upgrade of software for navigation module insert the provided SD card with upgrade software and reboot the device by disconnecting and reconnecting power. The upgrade process will start automatically and once completed touch calibration screen will start.

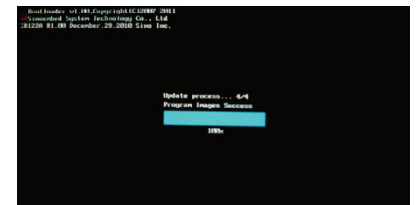

FAQs:

1. Navigation video is slightly out of position.

In case the video is slightly out of position, it is usually a few centimeter's up or down of optimal position. There are two adjusting methods:

(1) Open navigation settings - Screen - screen settings, there you can adjust the position of the navigation video.

(2) Press the left menu key on the interface box (there are 3 side keys on the interface box) : There will appear options, you can adjust the image's horizontal and vertical position.

2. Black screen when switching to reverse.

Check whether the relay interface cable installed correctly.

3. The parking guideline not be displayed, incorrect, do not move, or bounce.

Please check whether the parking guideline is switched" ON".

4. The navigation touch is not working properly.

Did no configure the navigation properly (calibrate method: pull out the navigation map card, power off and restart the navigation module, after 10-30 seconds touch calibration option will appear. Follow the calibration steps until "OK" icon is shown. Put the map in after calibration).

Optional Accessories:

1. Smartphone Receiver:

This is a specially designed HDMI receiver box that converts HDMI to High definition RGB input for the interface.

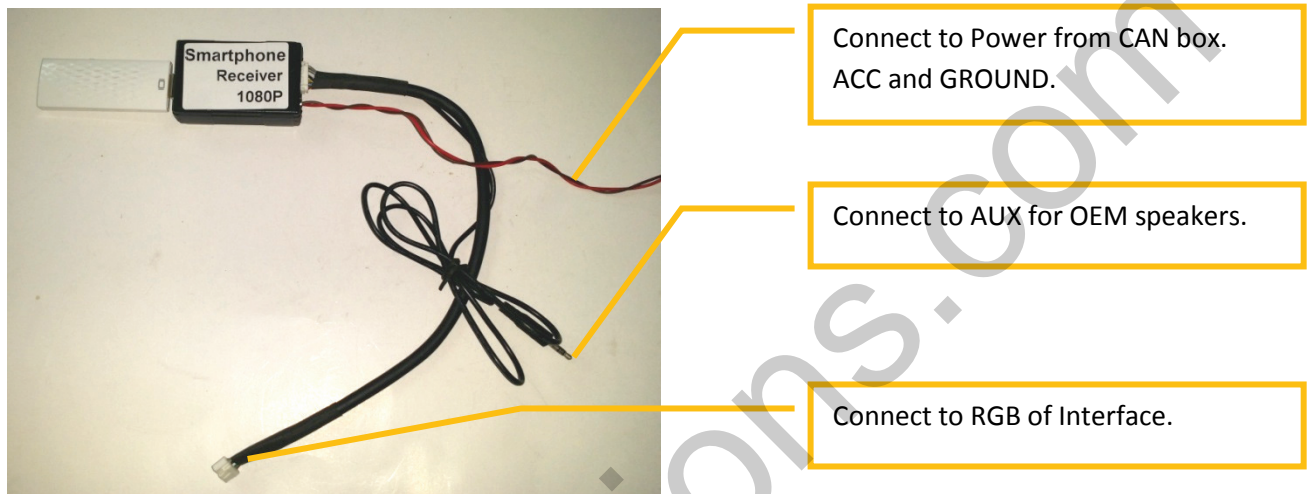

The HDMI in can be used to connect to phones directly (phones equipped with HDMI out function).

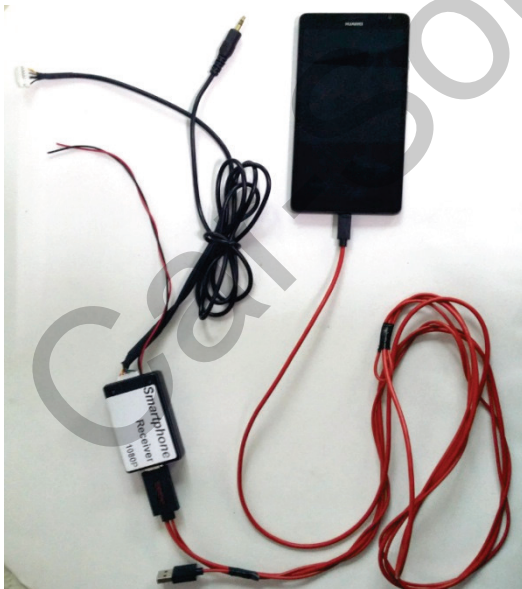

Support for MHL converter for Samsung phones.



Support for Apple Lightning to HDMI converter.

It can also be connected to Wireless Smartphone dongle(also provided as optional) to display the phones screen through Miracast, Airplay or DLNA.



Miracast wireless mirroring for Android phones.



Airplay or DLNA wireless mirroring for IOS phones.

To connect the Smartphone receiver connect the RGB cable to the RGB port on interface. Connect the red and black power cable to ACC and GND from CAN box to give power to the converter.

Make sure to select the DIP4 on interface to be OFF and DIP1 on interface should be ON.

The AUX can be connected for sound (make sure to turn sound on from phone to HDMI) or directly connect sound from phone using AUX cable separately.

When connecting to Android or Iphone for mirroring please check with phone how to connect wireless display. Follow simple process to have phones content on cars OEM screen.

****For more assistance please contact the sales team.****