

model : PIP-RGB-HE-STD-V5 / product code : PIP-RG-0810-861

Video Interface for Porsche Cayenne with PCM 2.1 User Guide

1.1 Features

- POP(Picture On Picture) Function (Only available on navigation mode)
- Auto detection for NTSC & PAL&SECOM signals.
- Parking Guide Line function added
- "Sync On Green" supported (Auto detection)
- Able to change modes via mode switch
- Able to change modes via using the original buttons
(Soldering point will be different depending on car models)
- OSD Menu added (Controlled by Remote control)

1.2 Main Specification

1. Input Spec. (MULTI VIDEO INTERFACE)

- 3 x AV Input (External video source).
- 1 x CVBS (REAR CAMERA) Input (Rear camera source)
- 1 x Analog RGB Input (Car commander original monitor output)
- 1 x Analog RGB Input (Navigation System output)-→OPTION

2. Output Spec.

- 2 X CVBS OUTPUT (Video Out for installing Headrest monitor)
- 1 x Audio OUTPUT
- 1 X LCD OUTPUT(LCD Operation)
- 4 X Audio Select Output

3. Power Spec.

- Input Power : 8VDC ~ 24VDC
- Consumption Power : 5WATT, Max

4. Switch Input mode

- NAVI/CVBS1,2 Original MUTE Function : Possible to mute each input by operating Dip S/W
- Possible to switch Input mode with remote control or toggle switch.
- Rear View Camera mode : When to sense rear gear power, be switched to Rear view camera mode
(Impossible to switch to rear mode with Toggle S/W or the remote control)

1.3 System Diagram

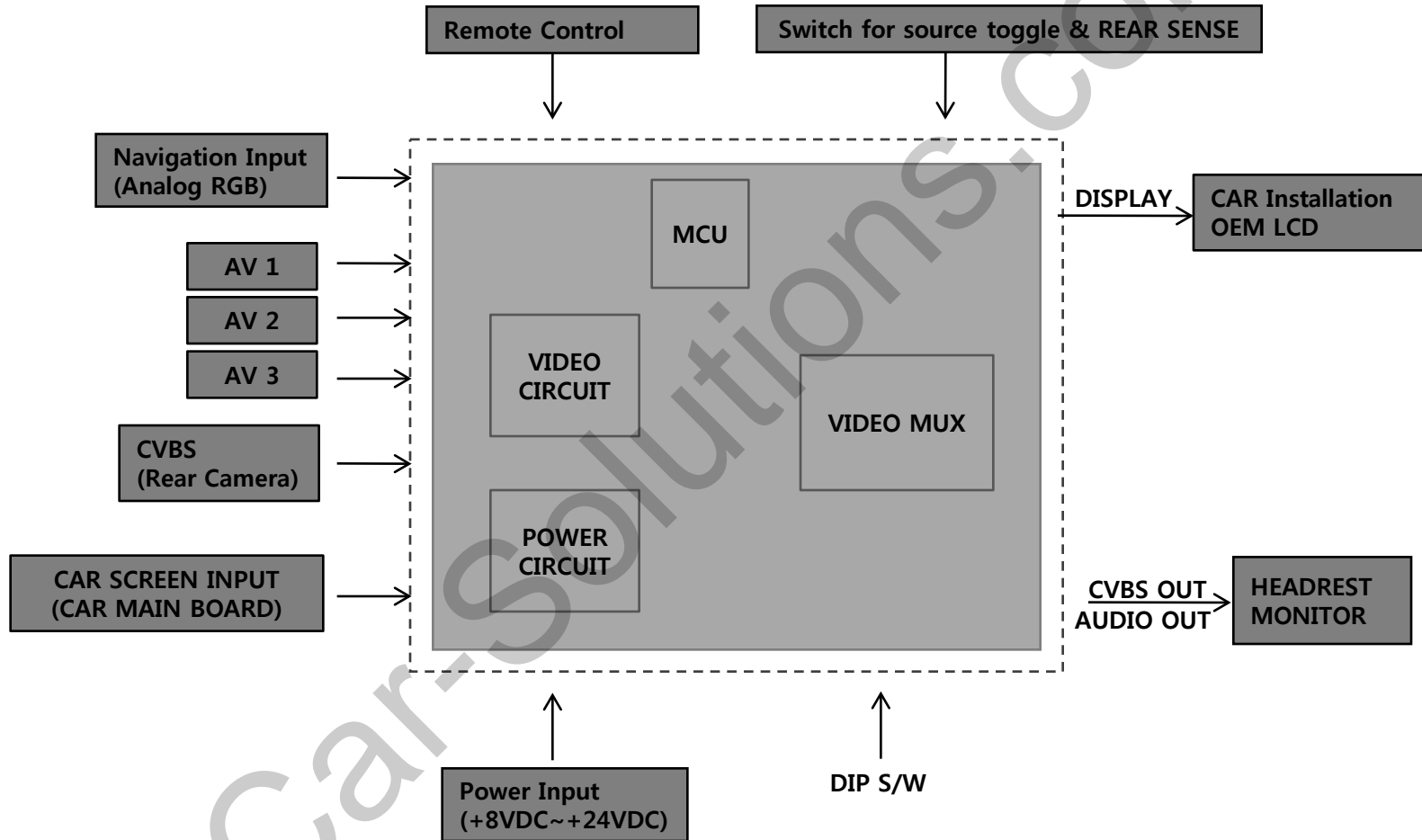

1.4 Components



GROUND cable (14P) * 1ea
(HGROUN0002)

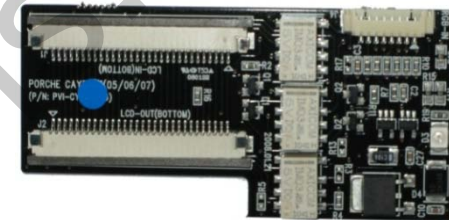

Sub-board * 1ea
(QCPASS0065)



FFC cable (30P) * 1ea
(FFCABL0002)

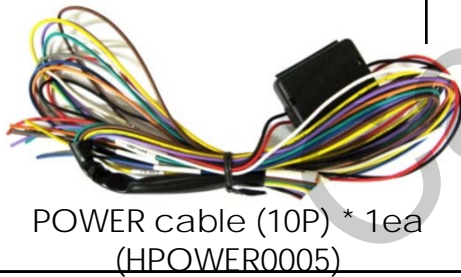
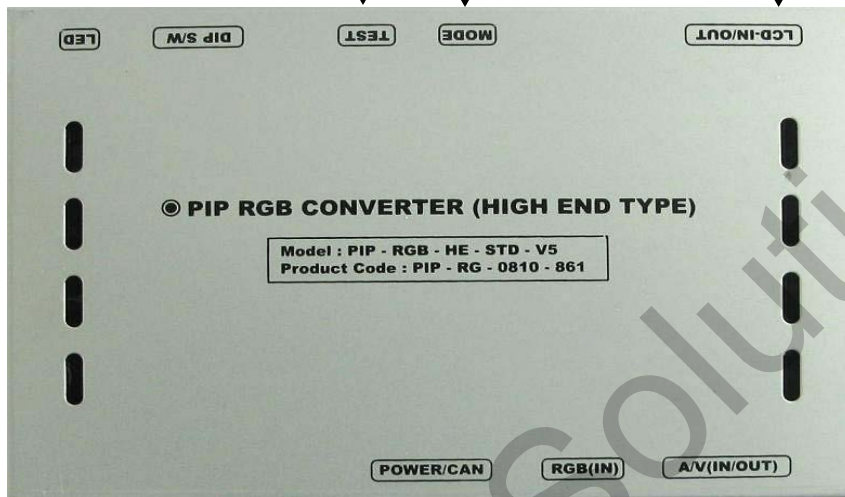

POWER cable (10P) * 1ea
(HPOWER0005)



RGB cable * 1ea
(HNAVIC0002)

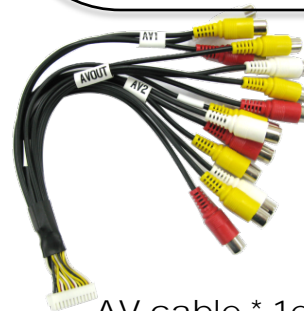

AV cable * 1ea
(HAVCAB0002)



REMOTE CONTROL * 1ea
(REMOTE0001)

1.4 Exterior



Dimension

Horizontal length 150mm
Vertical length 95mm
Height 21mm

1.5 Wiring diagram

* Power cable

FILTER
& FUSE BOX

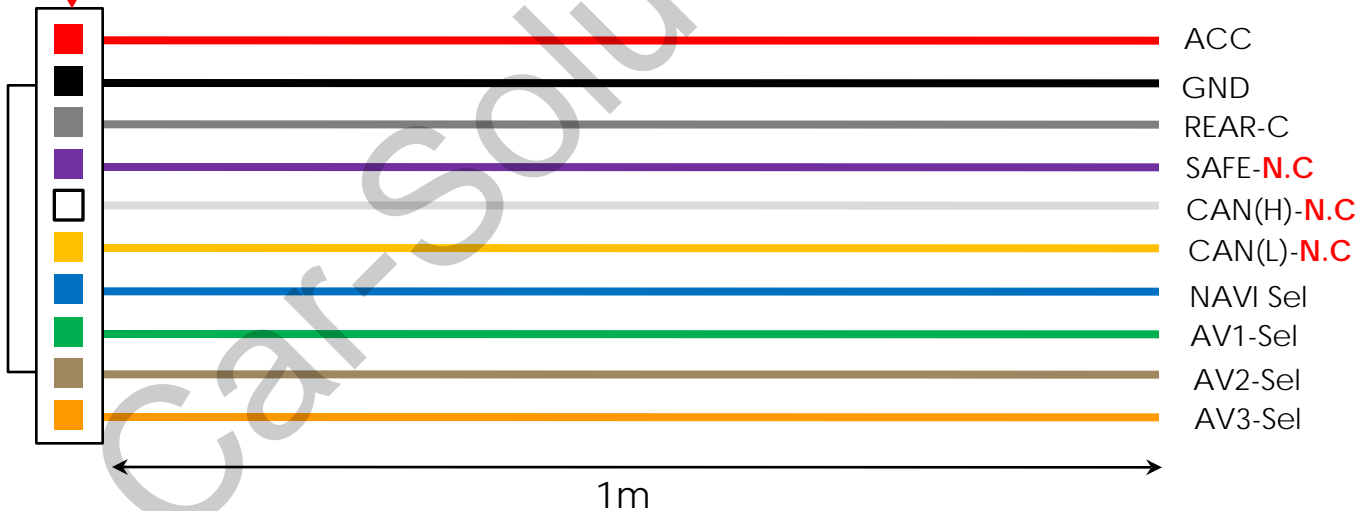
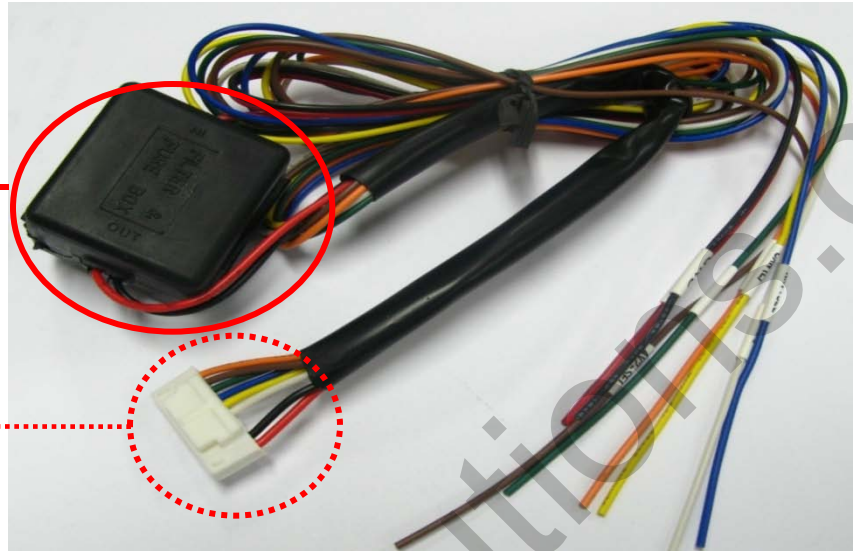

2.1 DIP switch

※ ON : DOWN, OFF : UP

#PIN	Function	DIP S/W selection
1	RGB INPUT MUTE	ON : Skipping RGB Mode OFF : RGB Display
2	AV1 MUTE	ON : Skipping AV1 OFF : AV1 Display
3	AV2 MUTE	ON : Skipping AV2 OFF : AV2 Display
4	AV3 MUTE	ON : Skipping AV3 OFF : AV3 Display
5	OEM MUTE	ON : Skipping OEM OFF : OEM Display
6		N.C
7	REAR MODE	ON : External Rear Camera OFF : OEM Rear Camera
8		N.C

※DIP S/W Use Example

- Use Input Mode : AV1, Navigation (RGB), Main
- Rear Camera : When to be installed on CVBS 4

- ▷ DIP S/W : 1 → OFF
- ▷ DIP S/W : 2 → OFF
- ▷ DIP S/W : 3 → ON
- ▷ DIP S/W : 4 → ON
- ▷ DIP S/W : 5 → OFF
- ▷ DIP S/W : 6 → OFF
- ▷ DIP S/W : 7 → ON (enable CVBS4)
- ▷ DIP S/W : 8 → OFF



2.2 Remote controller

Dimension : 85 * 40 * 8 (mm)



Key	Function
POWER & PIP	Not for use
MENU	OSD implementation
OK	Making a selection
▲	Move upward, control of POP position
▼	Move downward
◀	Move leftward
▶	Move rightward

*FACTORY MODE (Interface setting)

: Operated with pressing ▲ -> ▼ -> ▲ ->MENU buttons of the remote in sequence.

(Example : PIP implementation)



2.3 OSD (On Screen Display)

Analog RGB

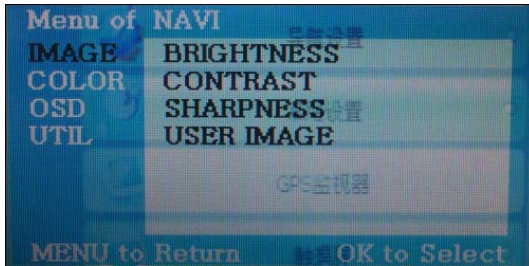

Analog RGB

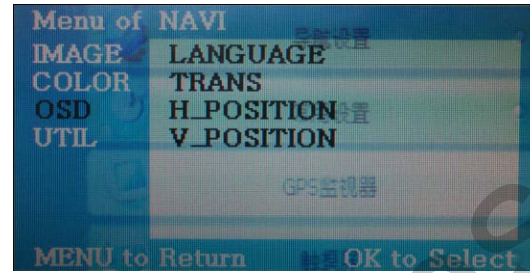

Analog RGB



Video



Video

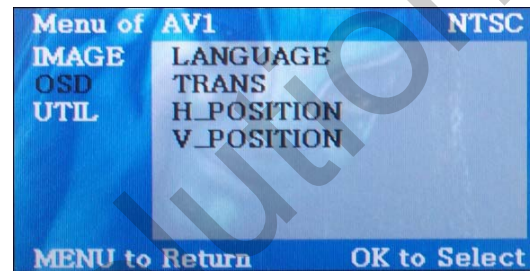

Video



IMAGE

- BRIGHTNESS
- CONTRAST
- SATURATION
- HUE
- SHARPNESS
- USER IMAGE : To choose a option among 4 prepared color shade.

OSD

- LANGUAGE : Choosing OSD language while using Touch OSD (English, Chinese only)
- TRANS : Transparency control of the OSD background
- H_POSITION : Horizontal movement of the OSD window
- V_POSITION : Vertical movement of the OSD window

UTIL

- FACTORY RESET : To reset all the values about navigation, DVD screen to factory default. (NOT available for reset of the position value of images, only for functions inside OSD menu)

2.3 OSD (On Screen Display)

- Factory Mode

- Operated with pressing ▲ -> ▼ -> ▲ ->MENU buttons of the remote in sequence.

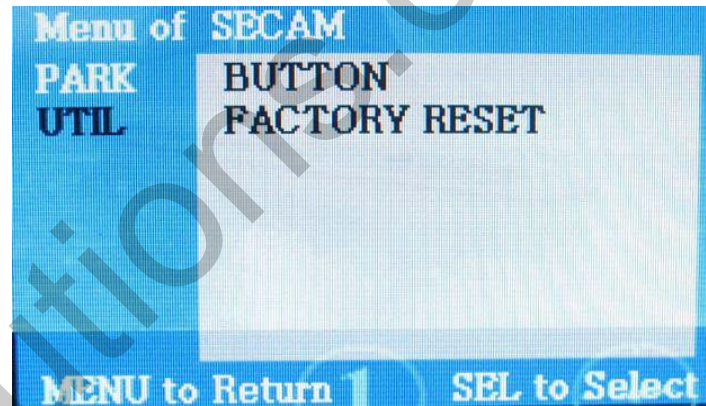
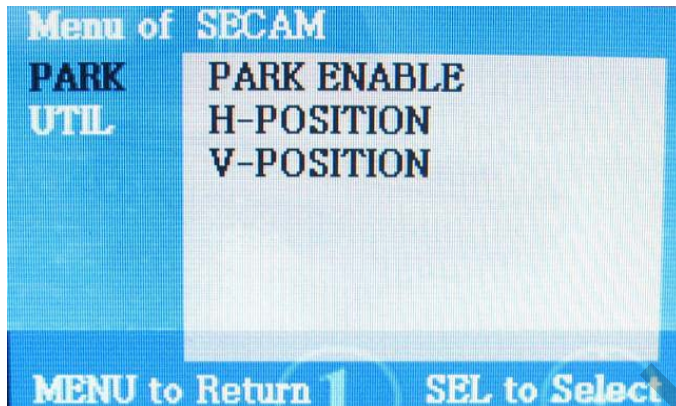

PARK

- PARK ENABLE
- H-POSITION
- V-POSITION

UTIL

- BUTTON : Car Model Setting for using Navi button
(Refer to the next page for details)
- FACTORY RESET : Initializing

2.3 OSD (On Screen Display)

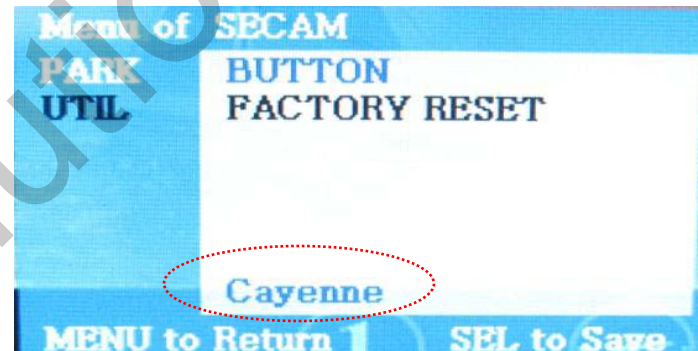
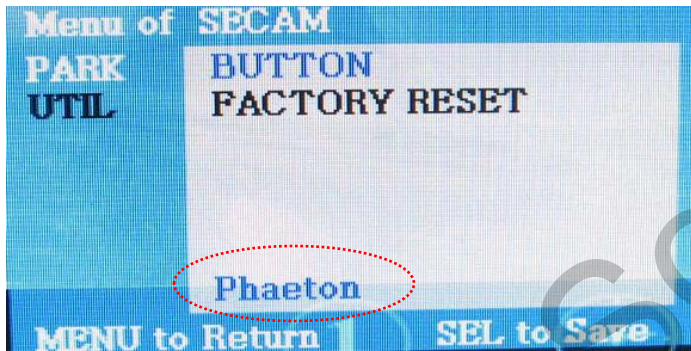
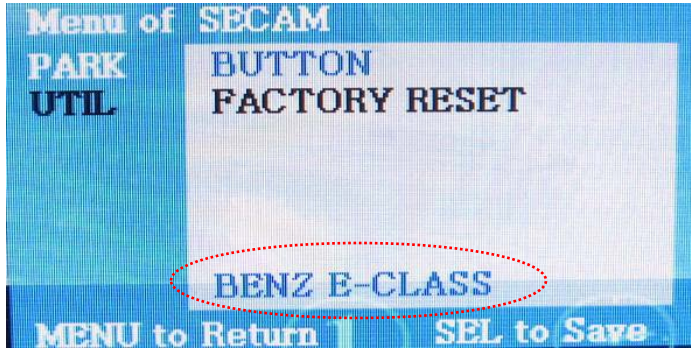

※ This setting needed with wire soldering, if want to use Navi button for switching AV sources. (Refer to the next page for further details.)

2.4 Parking guide line

* Factory Default : DISPLAY - DISABLE

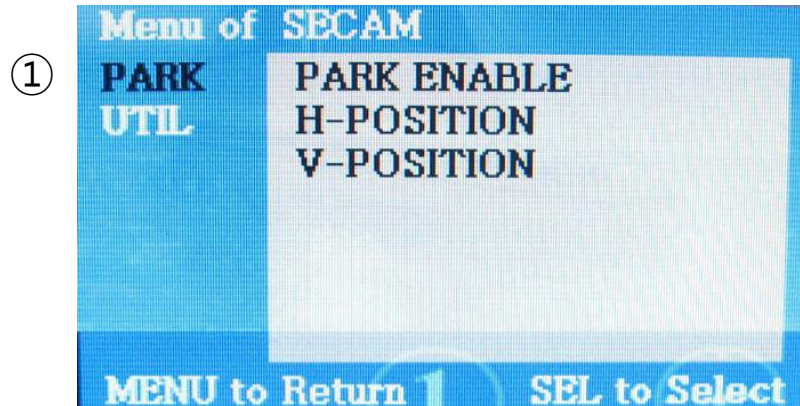

① When the car gear is in reverse, Enter to the Factory mode by ▲ → ▼ → ▲ → MENU button of remote control.

Then, the left image will be displayed on the screen.

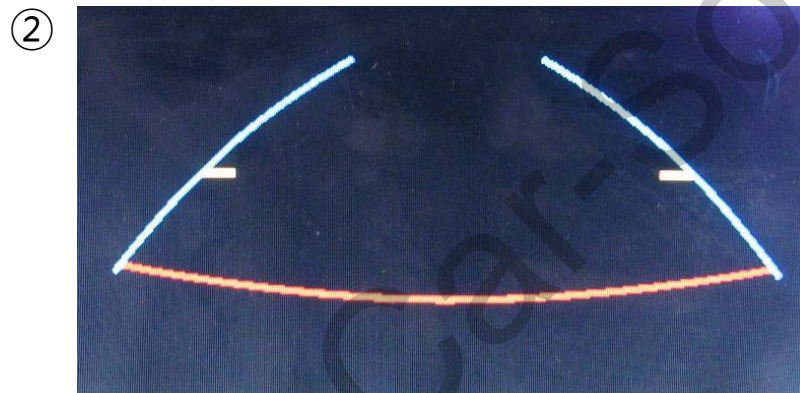

② Set "PARK ENABLE" to "ON" on the park mode, then the line will be displayed as shown left.

* If you would like to remove this line, just select "Off" on the above process.

2.4 Parking guide line

③

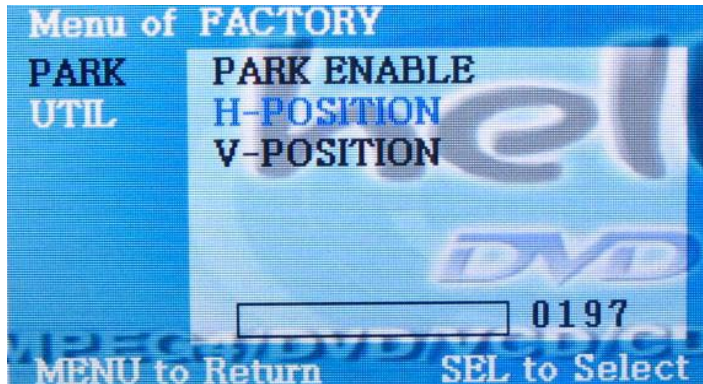

③ Can move the line with H-Position on the factory mode.

④

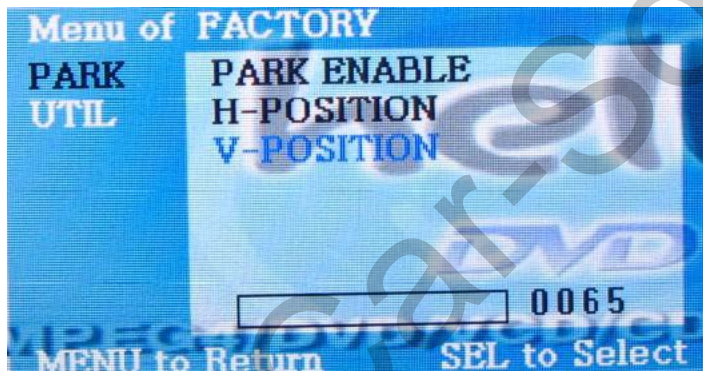

④ Can move the line with V-Position on the factory mode.

3.1 Cautions on installation

- Ignition key should be taken off before starting installation, interface power connection must be the last step in installation.
- Power cable should be separated when connecting interface.
- Should be no any electronic devices or magnetic pole around installation place.
- All steps of installation should be done by well-trained specialist.
- Dismantling without manufacturer's permission can not be guaranteed, (No permission to break attached label on the board.)
- Kindly check all parts are in the box, when receiving the product, if anything missing, inform to the supplier or manufacturer.
- According to our sales policy, any problems caused by user's mistake, careless can not be guaranteed.

3.2 Installation diagram

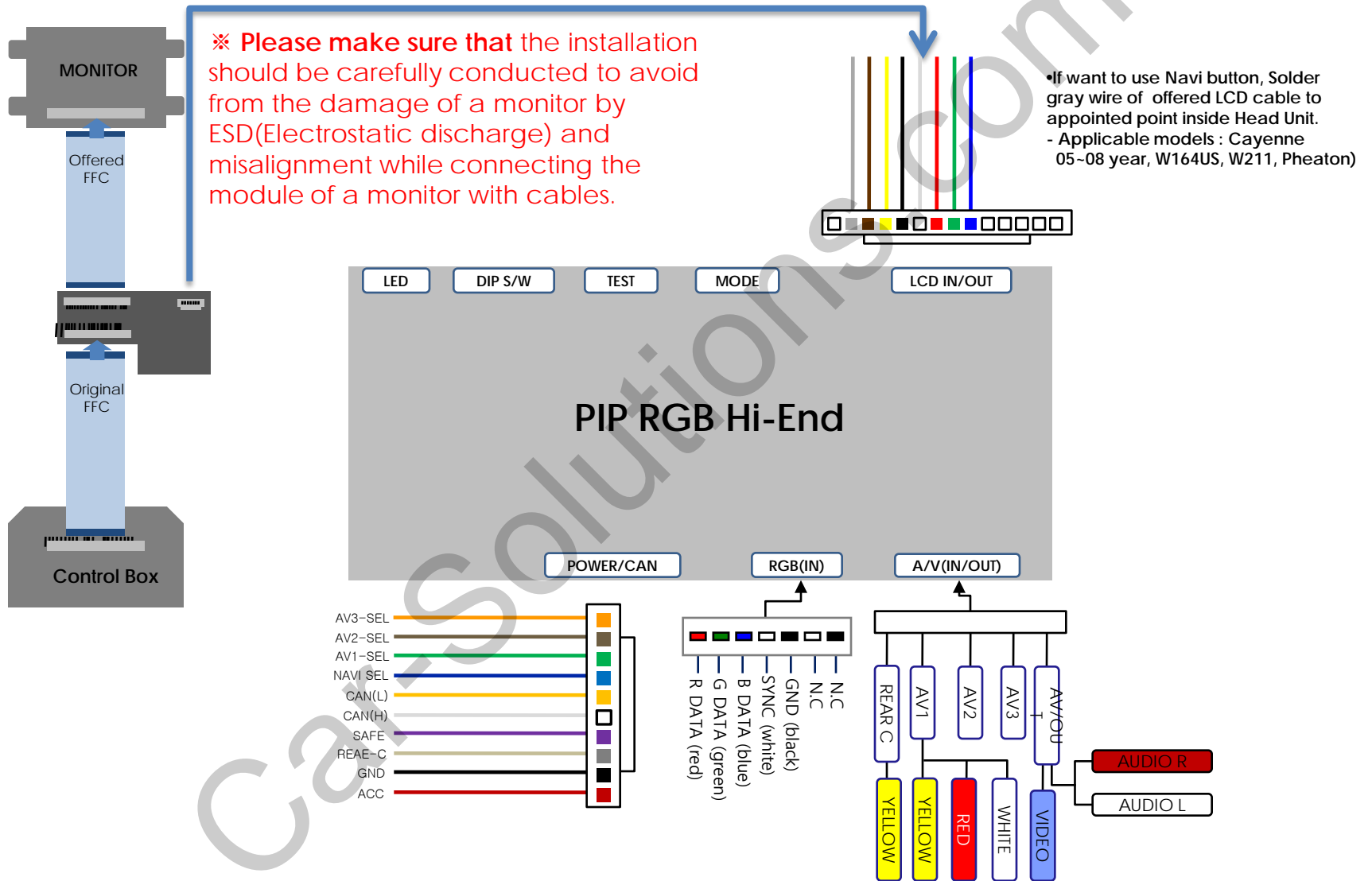

3.3 Soldering Point

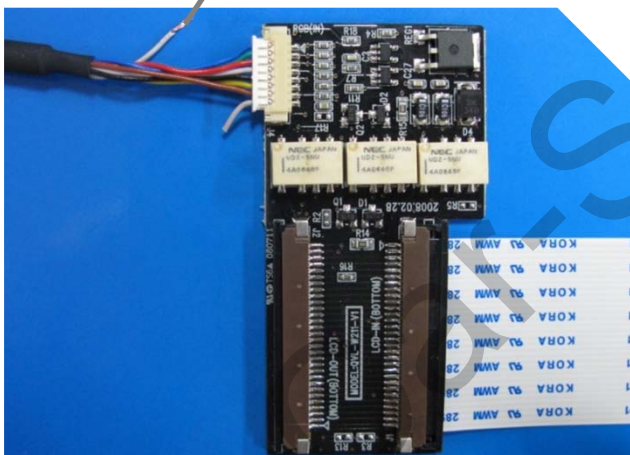

©Solder the gray wire on Ground cable which is connecting sub board with main board to the Head Unit as shown above.

*Soldering point: 5th Pin from right

*Original button : NAVI

4. Troubleshooting

Q. I can not switch A/V sources.

A. Check IR or Ground cable connection. Check LED lamps in the interface, if it is not on, check power cable.

Q. All I got on the screen is black.

A. Check second LED lamp of the interface is on, if not, check A/V sources connected are working well.

(Second lamp indicates AV sources connected works well.) Check interface connection has been done well.

Q. Displayed image color is not proper. (too dim or not suitable color)

A. Try to select "INITIAL" in OSD menu, if it does not work, inform the manufacturer.)

Q. Rear camera image does NOT appear.

A. Set DIP switch #7 in "ON"

Q. Unwanted A/V mode is displayed. (A/V source switching order : OEM->RGB->AV1->AV2->AV3)

A. Check DIP Switch Setting.

Q. OEM image is not displayed.

A. Check interface's LCD In/Out cable connection. If the status keeps on, inform the manufacturer.

Q. Screen only displays white like left picture.

A. Check LCD out cable is connected well, if this status keeps, inform the manufacturer.